

# HYDROMAGNETIC STABILITY OF A PLASMA

B. B. Kadomtsev

## Introduction

Plasma instabilities can be conveniently divided into two broad classes — hydrodynamic instabilities, and kinetic, or microscopic, instabilities. Hydrodynamic instabilities imply the displacement of macroscopic portions of plasma and can be analyzed theoretically through the use of the hydrodynamic equations. In other words it is assumed, as an approximation, that all the charged particles within a given macroscopic volume execute the same average motion.

On the other hand kinetic, or microscopic, instabilities can be defined as instabilities for which the differences in the motion of different particles in the same volume is important. A typical example of a kinetic instability is the two-stream instability; this instability arises as a result of the interaction between particles in a beam and the electrons and ions in a plasma. In general, kinetic instabilities are characterized by high frequencies and short wavelengths, and it is in this sense they are regarded as "microscopic" as compared with the large-scale and slower hydrodynamic instabilities.

Since hydrodynamic instabilities imply the displacement of a plasma in space, they are especially pertinent in cases in which macroscopic motion is important. The results of the theory of hydrodynamic instabilities or, more precisely, hydromagnetic instabilities, are useful in astrophysics (for example, see [8]) and in the problem of controlled thermonuclear fusion.

One of the early papers in this field by Leontovich [1] considered the stabilizing effect of a conducting wall on hydrodynamic flow, while a paper by Leontovich and Shafranov [2] treated the stabilizing effect of a longitudinal magnetic field on a flow. These questions were later considered in greater detail by Shafranov [4, 6].

relaxation of the ideal conductivity feature leads to the appearance of new instabilities. In § 11 we consider the current-convective instability; this instability occurs in a current-carrying pinch if the plasma conductivity is a function of position. The "superheating" instability, which develops under typical conditions when the plasma conductivity depends on temperature, is treated in § 12. The mechanism responsible for the superheating instability, which can be important when the conductivities parallel and transverse to the magnetic field are different, was first pointed out by Leontovich and then treated by Shafranov and Braginskii. In the present review, stability will be investigated in the linear approximation only, i.e., we shall only consider infinitesimally small perturbations. If one adopts the point of view that an absolutely stable plasma state is excluded by the usual conditions encountered in unstable plasmas, considerable interest attaches to the question of the ultimate development of plasma instabilities. This question, which involves the analysis of various kinds of nonlinear effects, has been investigated with some success at the present time; however, any nonlinear analyses would take us beyond the framework of the present review.

### § 1. Equation for Small Oscillations

Mathematically the problem of stability reduces to an investigation of small oscillations about an equilibrium state. If the oscillation amplitudes are small, the linearized equations of motion can be used. Let  $\rho$ ,  $p$ , and  $\mathbf{B}$  represent small deviations of the density, pressure, and magnetic field from the equilibrium values  $\rho_0$ ,  $p_0$ , and  $\mathbf{B}_0$ . The linearized equations of magnetohydrodynamics can then be written in the form

$$\frac{\partial \rho}{\partial t} + \operatorname{div}(\rho_0 \mathbf{v}) = 0, \quad (1.1)$$

$$\rho_0 \frac{\partial \mathbf{v}}{\partial t} + \nabla p = \frac{1}{4\pi} [\operatorname{rot} \mathbf{B}_0, \mathbf{B}] + \frac{1}{4\pi} [\operatorname{rot} \mathbf{B}, \mathbf{B}_0], \quad (1.2)$$

$$\frac{\partial p}{\partial t} + \nabla \nabla p_0 + \gamma p_0 \operatorname{div} \mathbf{v} = 0, \quad (1.3)$$

$$\frac{\partial \mathbf{B}}{\partial t} = \operatorname{rot} [\mathbf{v} \mathbf{B}_0], \quad (1.4)$$

where  $\mathbf{v}$  is the plasma velocity and  $\gamma$  is the adiabaticity index (specific-heat ratio).

It is frequently not convenient to use the velocity  $\mathbf{v}$ ; rather, one treats the plasma displacement from an equilibrium position  $\boldsymbol{\xi}$ , in which case  $\mathbf{v} = \partial \boldsymbol{\xi} / \partial t$ . Under these conditions, Eqs. (1.1), (1.3), and (1.4) can be integrated

The problem of plasma confinement by a magnetic field was also treated in a paper by Kruskal and Schwarzschild [7]. These early investigations were followed by a large number of investigations of the stability of an ideal plasma in a magnetic field and at the present time this topic has been studied quite extensively.

It is our purpose, in the present review, to present a systematic picture of the basic aspects of hydromagnetic stability of an ideally conducting plasma (with the exception of §§ 11 and 12, in which we consider the effect of finite conductivity). In keeping with this purpose, the basis of our investigation will be the equations of single-fluid magnetohydrodynamics. In this work we shall not treat drift instabilities, whose analysis requires two-fluid hydrodynamics (the electron and ion fluids), or the kinetic instabilities, which derive basically from the fact that the particles exhibit a distribution in velocity; these questions have been treated in a review by Vedenov, Velikhov, and Sagdeev [33]. Furthermore, in this review we shall only consider equilibrium systems, that is to say, it will be assumed in all cases that the plasma is quiescent in the initial state.

In § 1 we derive the equations for small oscillations of an inhomogeneous plasma. § 2 is devoted to the so-called energy principle. This principle has been formulated most completely in the work of Bernstein, Frieman, Kruskal, and Kulsrud [15] although it had also been used earlier [12-14]. According to the energy principle, in investigating the hydromagnetic stability of an ideal plasma one need only consider the potential energy associated with the small oscillations [Eq. (2.7)].

It is shown in § 3 that a convex plasma boundary is unstable in the absence of a "frozen-in" magnetic field; on the other hand, a concave boundary is shown to be stable. In §§ 4-6 we consider convective plasma instabilities (Longmire and Rosenbluth [16], Kadomtsev [17]).

The stability of a pinch carrying a longitudinal current is treated in § 7; in particular, the Shafranov-Kruskal condition for stability with respect to the so-called kink instability is derived. The physical meaning of this "helical" instability is examined in § 9. In § 8 we consider the stability of a pinch with a current distribution; in particular, we derive the criterion for the absence of a convective instability (the Suydam condition [19]) and analyze the stability of a thin skin layer (after Rosenbluth). The stability of toroidal systems is discussed in § 10.

The stability of a plasma with finite conductivity has not been investigated to any great extent at the present time. For this reason, in the present review we shall only examine two particular examples, in which the

with respect to time and  $\rho$ ,  $p$ , and  $\mathbf{B}$  can be expressed explicitly in terms of  $\xi$ :

$$\mathbf{Q} = -\operatorname{div}(\xi \mathbf{Q}_0), \quad p = -\xi \nabla p_0 - \gamma p_0 \operatorname{div} \xi, \quad \mathbf{B} = \operatorname{rot} [\xi \mathbf{B}_0]. \quad (1.5)$$

Substitution of these expressions in Eq. (1.2) results in a single second-order differential equation for  $\xi$ :

$$\begin{aligned} \mathbf{Q}_0 \frac{\partial^2 \xi}{\partial t^2} = & \nabla (\xi \nabla p_0 + \gamma p_0 \operatorname{div} \xi) + \frac{1}{4\pi} [\operatorname{rot} \mathbf{B}_0, \operatorname{rot} [\xi \mathbf{B}_0]] + \\ & + \frac{1}{4\pi} [\operatorname{rot} \operatorname{rot} [\xi \mathbf{B}_0], \mathbf{B}_0]. \end{aligned} \quad (1.6)$$

This equation must be supplemented by boundary conditions. Under laboratory conditions a plasma is usually surrounded by a conducting wall at whose surface the tangential component of the electric field  $E_t$  must vanish (with the obvious possible exception of gaps in the wall). It follows that the normal component of the magnetic field  $B_n$  must also vanish at this wall. If the plasma is in contact with a fixed conductor, in particular the wall, the condition  $E_t = 0$  necessarily implies that  $[\xi \mathbf{B}_0]_t = 0$  at the surface of all conductors. In general, this condition means that the displacement  $\xi$  must vanish at the point of contact. However, in certain frequently encountered cases, in which  $\mathbf{B}_0$  is tangential to the surface of the conductor, this condition reduces to the simpler one  $\xi_n = 0$ .

From the point of view of thermal isolation of a high-temperature plasma, special interest attaches to equilibrium plasma states in which the plasma is not in contact with external conductors, but is separated from them by a vacuum region (negligibly small plasma density). This case is obviously one of greater generality and raises the question of the appropriate boundary conditions to be imposed at the boundary of the region occupied by the plasma.

Let  $S_0$  represent the equilibrium boundary between the plasma and the vacuum. To be general we assume that a surface current flows at the plasma boundary so that the plasma pressure and magnetic field can exhibit finite discontinuities across this current sheet. A boundary of this kind is essentially a mathematical idealization of a very thin transition layer; in the equilibrium state this layer represents an ensemble of surfaces of constant pressure, the equilibrium boundary  $S_0$  itself being a surface of constant pressure. For this reason, the normal component of the magnetic field must vanish at  $S_0$ . Furthermore, it follows from the equilibrium equation

$$\nabla p_0 = \frac{1}{4\pi} [\operatorname{rot} \mathbf{B}_0, \mathbf{B}_0] \quad (1.7)$$

that the total pressure  $p_0 + B_0^2/8\pi$  is also a continuous quantity across the surface, i. e.,  $p_0 + B_0^2/8\pi = B_0^2 e/8\pi$ , where  $B_{0i}$  is the field in the interior region while  $B_{0e}$  is the field in the region external to the plasma.

A similar pressure balance condition must be observed in the displacement of the surface if the acceleration of the boundary is to remain finite. The specific condition is of the form

$$p_0 + p + \frac{1}{8\pi} (\mathbf{B}_{0i} + \mathbf{B}_i)^2 = \frac{1}{8\pi} (\mathbf{B}_{0e} + \mathbf{B}_e)^2. \quad (1.8)$$

All quantities appearing here are taken at the displaced boundary, i. e., at the point  $\mathbf{r} = \mathbf{r}_0 + \xi_n \mathbf{n}_0$ , where  $\mathbf{r}_0$  is a point on the surface  $S_0$  and  $\mathbf{n}_0$  is the normal to  $S_0$  at this point,  $\xi_n = (\mathbf{n}_0, \xi)$ . Expanding (1.8) in powers of the small quantity and retaining linear terms, we obtain one of the boundary conditions:

$$-\gamma p_0 \operatorname{div} \xi + \frac{B_{0i} B_i}{4\pi} = \frac{B_{0e} B_e}{4\pi} + \frac{\xi_n}{8\pi} \left( \frac{\partial B_{0e}^2}{\partial n} - \frac{\partial B_{0i}^2}{\partial n} \right), \quad (1.9)$$

where the values of all quantities are taken at an arbitrary point on the equilibrium boundary  $S_0$ .

The second boundary condition derives from the ideal conductivity of the plasma; specifically, it derives from the fact that the lines of force are frozen in the plasma. Since the plasma conductivity is assumed to be infinite,  $\mathbf{E}^* = \mathbf{E} + (1/c) [\mathbf{v} \mathbf{B}_0]_i$ , the electric field in the coordinate system fixed in the fluid vanishes identically. Then, by virtue of the continuity of the tangential component of the electric field  $E_t^*$  outside of the plasma, this field must also vanish:

$$\mathbf{E}_t + \frac{1}{c} [\mathbf{v} \mathbf{B}_{0e}]_t = 0. \quad (1.10)$$

Since both terms here are first-order quantities, we can assume that this condition is satisfied at the unperturbed boundary, in which case it can be written in the form:

$$[\mathbf{n}_0 \mathbf{E}] = \frac{1}{c} v_n B_{0e}. \quad (1.11)$$

Now, by virtue of the Maxwell equation  $\operatorname{div} \mathbf{B} / \partial t = -c \operatorname{rot} \mathbf{E}$ , the normal component of the magnetic field can be expressed entirely in terms of the tangential component of the electric field and Eq. (1.10) can be written in the form

$$(\mathbf{n}_0 \mathbf{B}_e) = n_0 \operatorname{rot} [\xi \mathbf{B}_{0e}]. \quad (1.12)$$

Outside of the plasma (in the vacuum) the electric and magnetic fields can be written in terms of the vector potential:  $E_e = -(1/c)(\partial A/\partial t)$  and  $B_e = \text{rot } A$ , where  $A$  is subject to the gauge condition  $\text{div } A = 0$ . Since there are no currents in this region,  $A$  satisfies the equation

$$\text{rot rot } A = 0. \quad (1.13)$$

The boundary condition in (1.12) can obviously be written in the form

$$[n_0 A] = -\xi_n B_{0e}. \quad (1.14)$$

Furthermore, the potential  $A$  satisfies the condition

$$[nA] = 0 \quad (1.15)$$

at the metal wall.

Thus, the problem of small oscillations of the plasma about an equilibrium state reduces to the solution of Eqs. (1.6) and (1.13) subject to the boundary conditions (1.9) and (1.14) at the free plasma boundary and the boundary conditions (1.15) at the conducting wall.

Since the equations are linear, the time-dependence of all quantities can be expressed in the form  $\exp(-i\omega t)$ . All relations then remain unchanged when the time factor is suppressed, with the exception of Eq. (1.6), in which the quantity  $Q_0 \omega^2 \xi$  appears on the left side. Under these conditions, the instability problem reduces to an eigenvalue problem.

It will be shown in § 2 that the square of the frequency of the characteristic oscillations  $\omega^2$  is a real quantity in an ideal plasma (which is considered here). Hence, if all of the eigenvalues  $\omega_i^2$  are positive, the corresponding equilibrium state is stable. If this condition is not satisfied, i.e., if at least one eigenvalue  $\omega_i^2$  is negative, the perturbation increases exponentially in time and the equilibrium is unstable.

## § 2. Energy Principle

In the form in which it has been formulated in the preceding section, the problem of stability assumes that the characteristic oscillations have already been determined. In certain cases, characterized by simple geometries, the eigenvalue problem can actually be solved and such a solution gives a complete picture of the low-frequency oscillations of the plasma; in particular, the question of stability can be decided. However, in more complicated geometries the solution of the problem becomes one of appreciable mathematical difficulty. For this reason it is desirable to have a method of

evaluating the stability of a system without actually finding the characteristic frequencies. The energy principle serves this purpose ideally; this principle is based on the investigation of the potential energy associated with the small oscillations.

Before considering the energy principle itself, we shall first show that the equation for small oscillations (1.6) is self-adjoint. For this purpose we write this equation in the form  $\rho_0 \partial^2 \xi / \partial t^2 = -\hat{K} \xi = F(\xi)$ , where  $\hat{K}$  is an operator whose explicit form is given by the right side of Eq. (1.6). Physically,  $F(\xi)$  can be interpreted as a force, while  $\hat{K}$  can be regarded as "spring constant" for small displacements of the plasma from the equilibrium position.

We shall only be interested in the sufficient condition that must be satisfied for the operator  $\hat{K}$  to be self-adjoint. Consider a displacement  $\eta$  which, together with the vector potential  $Q$ , satisfies the same boundary conditions as  $A$  and  $\xi$ ; specifically,

$$[n_0 Q] = \eta_n B_{0e} \quad (2.1)$$

at the plasma boundary and

$$[nQ] = 0 \quad (2.2)$$

at a conducting wall.

To demonstrate self-adjointness, we must show that  $\int \eta \hat{K} \xi dr = \int \xi \hat{K} \eta dr$  for any  $\xi$  and  $A$  and any  $\eta$  and  $Q$  that satisfy the boundary conditions (1.14), (1.15), (2.1), and (2.2). Let us multiply  $\hat{K} \xi$  by  $\eta$  and integrate over the volume occupied by the plasma  $V_i$ . Integrating by parts, we have

$$\int_{V_i} \eta \hat{K} \xi dr = \int_{V_i} \left\{ \gamma p_0 \text{div } \eta \text{div } \xi + \frac{1}{4\pi} \text{rot} [\eta B_0] \text{rot} [\xi B_0] + \xi \nabla p_0 \text{div } \eta - \right. \\ \left. - \frac{1}{4\pi} [\eta \text{rot } B_0] \text{rot} [\xi B_0] \right\} dr + \oint_{S_0} \left( p + \frac{B_0 B_l}{4\pi} \right) \eta_n dS. \quad (2.3)$$

We now show that  $\eta$  and  $\xi$  appear in completely symmetric fashion in the volume integral on the right side of Eq. (2.3). This statement is obvious for the first two terms in the integrand, so that we need only consider the last two terms. The component of the displacement along the magnetic field  $\xi_{\parallel}$  does not appear in these terms. We note that  $\eta_{\parallel}$  also does not appear. Taking  $\eta = \eta_{\parallel} = \alpha B_0$ , and using the equilibrium condition (1.7), we find

$$\begin{aligned} \xi \nabla p_0 \operatorname{div} \eta_{\parallel} - \frac{1}{4\pi} [\eta_{\parallel} \operatorname{rot} \mathbf{B}_0] \operatorname{rot} [\xi \mathbf{B}_0] &= \xi \nabla (\mathbf{B}_0 \nabla \alpha) + \\ &+ a \nabla p_0 \operatorname{rot} [\xi \mathbf{B}_0] = \operatorname{div} (\eta_{\parallel} \cdot \xi \nabla p_0). \end{aligned}$$

Consequently, the corresponding integral can be transformed into a surface integral  $S_0$  which vanishes by virtue of  $\eta_0 \eta_{\parallel} = 0$ .

Let us now assume that  $\nabla p_0$  does not vanish identically. In this case, the direction of current flow does not coincide with that of the magnetic field and  $\xi$  and  $\eta$  can be expanded in terms of the vectors  $\mathbf{B}_0$ ,  $\operatorname{rot} \mathbf{B}_0$ , and  $\mathbf{e} = \nabla p_0 / |\nabla p_0|$ . However, since the component of the displacement along the field does not appear in the last two terms of the volume integral (2.3), we can write

$$\xi = \xi_1 \operatorname{rot} \mathbf{B}_0 + \xi_2 \mathbf{e} \quad \text{and} \quad \eta = \eta_1 \operatorname{rot} \mathbf{B}_0 + \eta_2 \mathbf{e}.$$

Using this representation of  $\xi$  and  $\eta$ , and the equilibrium condition, we find

$$\begin{aligned} -\frac{1}{4\pi} [\eta \operatorname{rot} \mathbf{B}_0] \operatorname{rot} [\xi \mathbf{B}_0] &= -\frac{\eta_2}{4\pi} [\mathbf{e} \operatorname{rot} \mathbf{B}_0] \operatorname{rot} \{4\pi \xi_1 \nabla p_0 + \xi_2 [\mathbf{e} \mathbf{B}_0]\} = \\ &= \eta \nabla p_0 (\operatorname{rot} \mathbf{B}_0 \nabla \xi_1) + \eta \nabla p_0 \operatorname{div} (\mathbf{e} \xi_2) + \eta_2 \xi_2 \frac{1}{4\pi} [\mathbf{e} \operatorname{rot} \mathbf{B}_0] \{(\mathbf{e} \nabla) \mathbf{B}_0 - \\ &\quad - (\mathbf{B}_0 \nabla) \mathbf{e}\}. \end{aligned}$$

Thus, the sum we are considering reduces to a form which is completely symmetric in  $\eta$  and  $\xi$ :

$$\begin{aligned} \xi \nabla p_0 \operatorname{div} \eta - \frac{1}{4\pi} [\eta \operatorname{rot} \mathbf{B}_0] \operatorname{rot} [\xi \mathbf{B}_0] &= \xi_{\perp} \nabla p_0 \operatorname{div} \eta_{\perp} + \eta_{\perp} \nabla p_0 \operatorname{div} \xi_{\perp} + \\ &+ (\eta \mathbf{e}) (\xi \mathbf{e}) \frac{1}{4\pi} (\mathbf{e} \operatorname{rot} \mathbf{B}_0) \{(\mathbf{e} \nabla) \mathbf{B}_0 - (\mathbf{B}_0 \nabla) \mathbf{e}\}. \end{aligned} \quad (2.4)$$

Now, we must transform to a symmetric form of the surface integral in Eq. (2.3). Taking account of the boundary conditions (2.1) and (2.2) for  $\mathbf{Q}$ , and integrating by parts, we have

$$\oint_{S_0} \eta_{\parallel} (\mathbf{B}_0 \operatorname{rot} \mathbf{A}) dS = \int_{V_e} \{\operatorname{rot} \mathbf{A} \operatorname{rot} \mathbf{Q} - \mathbf{Q} \operatorname{rot} \operatorname{rot} \mathbf{A}\} dr, \quad (2.5)$$

where the integral on the right is taken over the volume outside of the plasma.

Using this relation and adding mutually canceling terms in Eq. (2.3), we have

$$\begin{aligned} \int_{V_i} \eta \hat{\mathbf{K}} \xi dr + \frac{1}{4\pi} \int_{V_e} \mathbf{Q} \operatorname{rot} \operatorname{rot} \mathbf{A} dr - \oint_{S_0} \left\{ -\gamma p_0 \operatorname{div} \xi + \frac{\mathbf{B}_0 \mathbf{B}_0}{4\pi} - \right. \\ \left. - \frac{1}{8\pi} \xi_{\parallel} \left( \frac{\partial B_{0e}^2}{\partial n} - \frac{\partial B_{0i}^2}{\partial n} \right) - \frac{\mathbf{B}_{0e} \operatorname{rot} \mathbf{A}}{4\pi} \right\} \eta_{\parallel} dS = \int_{V_i} \left\{ \gamma p_0 \operatorname{div} \eta \operatorname{div} \xi + \right. \\ \left. + \frac{1}{4\pi} \operatorname{rot} [\eta \mathbf{B}_0] \operatorname{rot} [\xi \mathbf{B}_0] + \xi \nabla p_0 \operatorname{div} \eta - \frac{1}{4\pi} [\eta \operatorname{rot} \mathbf{B}_0] \operatorname{rot} [\xi \mathbf{B}_0] \right\} dr + \\ + \frac{1}{4\pi} \int_{V_e} \operatorname{rot} \mathbf{A} \operatorname{rot} \mathbf{Q} dr + \oint_{S_0} \eta_{\parallel} \xi_{\parallel} \left( \frac{1}{8\pi} \frac{\partial B_{0e}^2}{\partial n} - \frac{\partial p_0}{\partial n} - \frac{1}{8\pi} \frac{\partial B_{0i}^2}{\partial n} \right) dS. \end{aligned} \quad (2.6)$$

Now consider the boundary condition (1.8), which expresses the pressure balance in the displacement of the boundary, and Eq. (1.13), which expresses the absence of current in the vacuum; when these conditions are taken into account only the first integral remains on the left side of Eq. (2.6). But this means that the integral  $\int \eta \hat{\mathbf{K}} \xi dr$  can be written in the form of the right side of Eq. (2.6), which is completely symmetric with respect to the vector pairs  $\xi$  and  $\mathbf{A}$  and  $\eta$  and  $\mathbf{Q}$ ; thus, the operator  $\hat{\mathbf{K}}$  is self-adjoint.

The fact that they are self-adjoint means that the small-oscillation equations can be obtained from a variational principle, i.e., a least-action formulation,  $\delta \int L dt = 0$ , where  $L$  is the Lagrangian, given by the difference between the kinetic energy  $T = \frac{1}{2} \int_{V_i} Q_0 \left( \frac{\partial \xi}{\partial t} \right)^2 dr$  and the potential energy

$$\begin{aligned} W = \frac{1}{2} \int_{V_i} \left\{ \gamma p_0 (\operatorname{div} \xi)^2 + \frac{1}{4\pi} (\operatorname{rot} [\xi \mathbf{B}_0])^2 + \xi \nabla p_0 \operatorname{div} \xi - \right. \\ \left. - \frac{1}{4\pi} [\xi \operatorname{rot} \mathbf{B}_0] \operatorname{rot} [\xi \mathbf{B}_0] \right\} dr + \frac{1}{8\pi} \int_{V_e} (\operatorname{rot} \mathbf{A})^2 dr - \frac{1}{2} \oint_{S_0} \left( \frac{\partial p_0}{\partial n} + \right. \\ \left. + \frac{1}{8\pi} \frac{\partial B_{0e}^2}{\partial n} - \frac{1}{8\pi} \frac{\partial B_{0i}^2}{\partial n} \right) \xi_{\parallel} dS. \end{aligned} \quad (2.7)$$

If the potential energy (2.7) is varied with respect to  $\xi$  and  $\mathbf{A}$  subject to the constraint imposed by the "freezing" conditions  $[\eta_0 \delta \mathbf{A}]_{S_0} = (\eta_0 \delta \xi) \mathbf{B}_{0e}$ ,  $[\eta \delta \mathbf{A}]_{S_e} = 0$ , an expression is obtained which coincides with the left side of Eq. (2.6) if  $\eta = \delta \xi$  and  $\mathbf{Q} = \delta \mathbf{A}$ . But the variation of the time integral of the kinetic energy is  $\delta \int T dt = - \iint Q_0 \frac{\partial^2 \xi}{\partial t^2} \delta \xi dr dt$ . Writing  $\delta \int L dt = 0$ , and taking account of the fact that the variations  $\delta \xi$  and  $\delta \mathbf{A}$  are

very short wavelengths, for which the boundary can be regarded as approximately plane. Now let us introduce a local coordinate system with  $x$  axis directed along the normal to the surface and  $z$  axis along the magnetic field. We assume that  $\xi_n = \xi_x$  has a simple dependence on  $y$  and  $z$ ; specifically:  $\xi_x = \xi_0 \exp(iky + ikz)$ . The potential  $\mathbf{A}$  can be written in the form  $\mathbf{A}_0 \exp(i\mathbf{k}\mathbf{r})$ , where  $\mathbf{A}_0 = \text{const}$ . Taking the minimum of (3.1) with respect to  $\mathbf{A}$ , we have  $\text{rot rot } \mathbf{A} = 0$ , i.e.,

$$k^2 \mathbf{A}_0 - k(\mathbf{A}_0 \mathbf{k}) = 0. \tag{3.2}$$

From the boundary condition (1.14) we have  $A_{0z} = 0, A_{0y} = -\xi_n n_{\theta 0}$ . Since the magnetic field  $\mathbf{B} = \text{rot } \mathbf{A} = i[\mathbf{k}\mathbf{A}]$  is determined only by the transverse component of  $\mathbf{A}$ , we can write  $kA_0 = 0$  without loss of generality; then, it follows from (3.2) that  $k^2 = 0$ , i.e.,  $k_x = -i\sqrt{k_y^2 + k_z^2} = -i\kappa$ . Assuming that  $A_x k_x + A_y k_y = 0$ , we have

$$|\text{rot } \mathbf{A}|^2 = 2k_z^2 B_{0z}^2 e^{-2\kappa z}.$$

Since the perturbation being considered does not change the amount of matter within the surface  $S_0$ , i.e.,  $\int_{S_0} \xi_n dS = 0$ ,  $\xi$  can extend into the plasma so that  $\text{div } \xi = 0$ , that is to say, this displacement acts as if it were "incompressible." In this case, the first integral in (3.1) vanishes and the other two integrals yield the value of  $W_S$ , the amount of energy per unit surface:

$$W_S = \left[ \frac{1}{8\pi} \cdot \frac{k_z^2 B_0^2}{\kappa} + \frac{1}{16\pi} \cdot \frac{\partial B_0^2}{\partial n} \right] \xi_0^2. \tag{3.3}$$

When  $\partial B_0^2 / \partial n < 0$ , it is evident that the potential energy becomes negative for perturbations characterized by  $k_z^2 / \kappa \rightarrow 0$ , i.e., perturbations with long wavelengths along the lines of force.

This perturbation is essentially a "flute" which is oriented along the lines of force (Fig. 1). This flute does not perturb the magnetic field to any great extent; instead, it "slips" through the lines of force without separating them greatly. If  $\partial B_0^2 / \partial n < 0$ , the end of the flute enters a region in which the magnetic pressure is smaller than  $p_0$ ; the resulting pressure differential causes further growth of the flute and eventually the flute grows without limit.

A similar instability occurs when  $\partial B_0^2 / \partial n = 0$  and the plasma is in a gravitational field in the direction of the magnetic field. In this case, the pressure of the magnetic field is uniform at all points, so that the force of gravity is not balanced in the flute; under these conditions, the flute is

arbitrary, we obtain Eqs. (1.6) and (1.13) and the boundary condition (1.7). By virtue of general theorems of mechanics, we then conclude that a necessary and sufficient condition for plasma stability is that the potential energy of the small vibrations (2.7) must be positive for any displacement  $\xi$  and potential  $\mathbf{A}$  which satisfy the boundary conditions (1.14) and (1.15). In other words,  $W$  must be characterized by a positive minimum.

We note that the energy principle can also be used to obtain the approximate frequencies of the characteristic oscillations (by means of direct variational methods). For example, if the time dependence of all quantities is written in the form  $\exp(-i\omega t)$ , the equation for small vibrations reduces to  $\omega^2 Q_0 \xi = K \xi$ ; this relation can be obtained from the variational principle  $\delta(\omega^2) = 0$ , where

$$\omega^2 = \frac{\int \xi K \xi dr}{\int Q_0 \xi^2 dr}. \tag{2.8}$$

In particular, it follows from the last expression that  $\omega^2$  is real. The energy principle is useful in cases in which one wishes to obtain a general idea of the stability of an equilibrium configuration. In simple cases it is advisable to solve the small-oscillation equations, because this procedure not only evaluates the stability of the system, but also yields information concerning the full set of oscillations, and this information may be of interest in its own right. For this reason, both the energy principle and the method of characteristic oscillations will be used in the present review.

### § 3. Stability of the Boundary Between a Plasma and a Magnetic Field

We now consider the simplest case, in which there is no magnetic field inside the plasma, so that all currents flow along the surface. Under these conditions the potential energy expression is simplified appreciably; specifically:

$$W = \frac{1}{2} \int_{V'} \nu \rho_0 (\text{div } \xi)^2 dr + \frac{1}{8\pi} \int_{V'} (\text{rot } \mathbf{A})^2 dr + \frac{1}{16\pi} \int_{S_0} \frac{\partial B_0^2}{\partial n} \xi_n^2 dS. \tag{3.1}$$

If  $\partial B_0^2 / \partial n > 0$ , i.e., if the magnetic field increases in all directions going away from the plasma boundary in the outward sense, the potential energy is positive and the plasma is stable. Now consider the inverse case, in which  $\partial B_0^2 / \partial n < 0$  over some portion of the surface  $S_0$ . It will be shown that in this case there is always at least one perturbation for which the potential energy is negative. For reasons of simplicity we shall only consider perturbations with

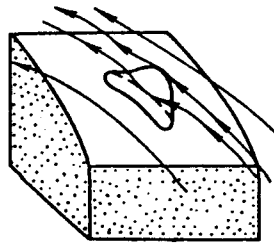

Fig. 1

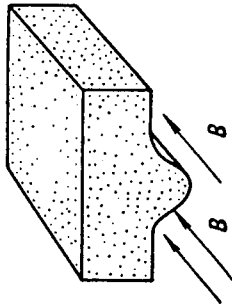

Fig. 2

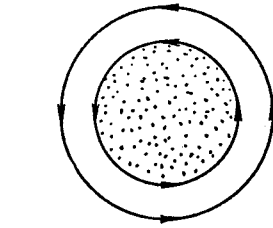

Fig. 3

accelerated downward (Fig. 2). This instability is evidently similar to the classic instability of Rayleigh and Taylor, who investigated the instability of a heavy liquid supported from below by a light liquid. However, the analogy is not complete since it only holds for perturbations which are extended along the lines of force. Perturbations for which  $k_z/\kappa$  is not a small quantity lead to a strong deformation of the magnetic field, tending to bend the lines of force, and thus do not lead to an instability. An example of this kind would be a flute oriented across the lines of force.

The classic Rayleigh-Taylor instability is essentially the limiting case of a convective instability of an inhomogeneous (or nonuniformly heated) fluid in a gravitational field. In precisely the same way, the instability of a plasma-field boundary is also the limiting case of a convective plasma instability (cf. §5). Hence, the flute perturbations considered above, which are almost constant along the lines of force, will be called convective perturbations.

To summarize: the boundary between a plasma and a field is stable only if the lines of force are concave, as seen from the plasma, in which case the magnetic field increases going away from the plasma. If the lines of force are convex, the boundary is unstable against convective perturbations (Fig. 3). This instability leads to fluting of the plasma surface along the lines of force and, in the final analysis, to the expulsion of plasma in the direction of weaker magnetic field. Under these conditions the positions of the plasma and the magnetic field can be interchanged so that convective instabilities are also called interchange instabilities in this context.

§ 4. Pinch with No Longitudinal Field

Let us consider a plasma pinch, i.e., a plasma column confined by the current flowing within the plasma itself; this configuration will serve as an example for the analysis of stability of a plasma in an "inside" region. We assume that the plasma occupies the entire region up to the conducting walls.

We shall use a cylindrical coordinate system  $r, \varphi$ , and  $z$  with  $z$  axis along the axis of symmetry. In the absence of a longitudinal magnetic field, the equilibrium equation can be written in the form

$$\frac{dp}{dr} = -\frac{B}{4\pi r} \frac{d}{dr}(rB) \tag{4.1}$$

(for simplicity, we have omitted the zero subscripts on the equilibrium quantities).

We first consider perturbations that are independent of the azimuthal angle  $\varphi$ . For these convective perturbations the potential energy is

$$W = \frac{1}{2} \int \left\{ \gamma p \left[ \frac{1}{r} \frac{\partial}{\partial r} (r\xi_r) + \frac{\partial^2 \xi_z}{\partial z^2} \right]^2 + \frac{1}{4\pi} \left[ B \frac{\partial^2 \xi_z}{\partial z^2} + \frac{\partial}{\partial r} (B\xi_r) \right]^2 + \xi_r \frac{dp}{dr} \left[ \frac{1}{r} \frac{\partial}{\partial r} (r\xi_r) + \frac{\partial^2 \xi_z}{\partial z^2} \right] + \xi_r \frac{dp}{dr} \left[ \frac{\partial^2 \xi_z}{\partial z^2} + \frac{1}{B} \frac{\partial}{\partial r} (B\xi_r) \right] \right\} dr. \tag{4.2}$$

Evidently, the integrand is a quadratic form in the two variables  $\xi_r$  and  $\text{div } \xi$ , which can be regarded as independent by virtue of the fact that  $\xi_r$  and  $\xi_z$  are independent.

It is well known that  $\sum_{ij} a_{ij} x_i x_j$ , a quadratic form of several variables  $x_i$ , is positive definite if all of the principal minors of the matrix  $a_{ij}$  are positive. By applying this criterion to (4.2), we can obtain the stability condition. Omitting some simple intermediate calculations, we write the criterion in the

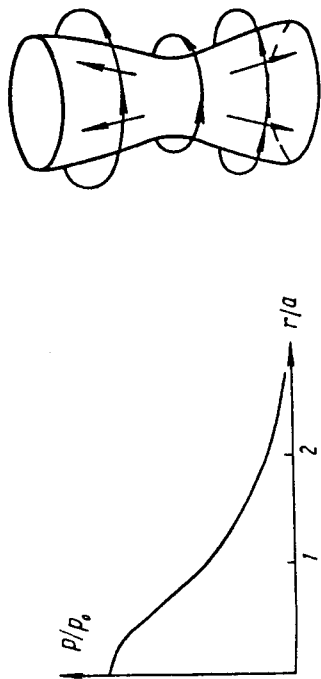

Fig. 4

Fig. 5

where  $\beta = 8\pi p/\beta^2$  is the ratio of the plasma pressure to the magnetic pressure.

The condition in (4.3) must be satisfied at all points  $r$ . Let us assume that this condition is actually violated near some point  $r_0$ . In this case, we can choose  $\xi_r$  and  $\text{div } \xi$ , say  $\xi_r = \alpha \text{div } \xi$ ,  $\alpha = \text{const}$ , so as to make the integrand negative in the vicinity of this point. Let us now form a local perturbation which falls to zero rapidly with increasing distance from  $r_0$ ; close to this point  $\xi_r = \alpha \text{div } \xi$ . This perturbation essentially represents the interchange of two force tubes. For example, if  $\alpha > 0$ , the tube with plasma will be expanded somewhat in being displaced along the radius, while the plasma that ties this tube to the axis will be compressed. The potential energy for this localized perturbation is determined only by the conditions in the vicinity of the point  $r_0$  and can be negative if (4.3) is not satisfied. If this happens, a convective instability can arise.

The condition in (4.3) implies that the plasma pressure must not diminish too rapidly with increasing  $r$ . Taking account of the equilibrium condition (4.1), which can be written in the form

$$\frac{d \ln p}{d \ln r} = \frac{1}{1 + \beta} \left( \frac{d \ln \beta}{d \ln r} - 2 \right), \quad \text{where} \quad \beta = \frac{8\pi p}{B^2},$$

and changing the inequality in (4.3) into an equality, we can obtain the limiting pressure distribution which is still stable against an axially symmetric perturbation. In parametric form this limiting pressure is given by (with  $\gamma = 5/3$ )

$$p = p_0 \left( \frac{\beta}{0.8 + \beta} \right)^{1/\alpha}; \quad r = a \frac{0.8 + \beta}{\beta^{1/\alpha}}. \quad (4.4)$$

Here,  $p_0$  is the pressure at  $r = 0$ , i.e.,  $\beta = 8\pi p/\beta^2 \rightarrow \infty$ , while  $a$  is the characteristic radius of the pinch. This distribution is shown in Fig. 4. According to (4.4), the plasma pressure cannot fall off more rapidly than  $r^{-2\gamma} = r^{-10/3}$  as a function of distance from pinch. If the pressure falls off more rapidly than this, then (4.4) indicates that the pinch is unstable against an axially symmetric perturbation. In particular, in the limiting case of a pinch with sharp boundaries the instability is manifest in a "necking" or sausage instability at the boundary (Fig. 5). The interchange nature of this instability is demonstrated particularly clearly under these conditions.

The sausage instability can be interpreted as the result of the compression of the lines of force around the neck, where the magnetic field is larger

than in the other portions of the boundary further removed from the axis. The stretching of the lines of force near the neck then forces the plasma out of this region.

We now consider perturbations which exhibit a functional dependence on the azimuthal angle  $\varphi$ . Since any perturbation can be expanded in a Fourier series, and since the different harmonics are orthogonal ( $\int \xi_i \xi_k dr = 0$ ), without loss of generality we can write the dependence on  $\varphi$  in the form

$$\xi_r = \xi_r(r, z) \sin m\varphi; \quad \xi_\varphi = \xi_\varphi(r, z) \cos m\varphi; \quad \xi_z = \xi_z(r, z) \sin m\varphi.$$

In this case, the integrand in (2.7) will contain factors such as  $\cos^2 m\varphi$  and  $\sin^2 m\varphi$  which yield a value of  $1/2$  when averaged. It is evident that the component of the displacement along the magnetic field  $\xi_\varphi$  appears only in the first term of the integrand (2.7) and if  $m \neq 0$ ,  $\xi_\varphi$  can always be chosen so that  $\text{div } \xi = 0$ . It is easy to show that the potential energy for these perturbations  $W$  differs from (4.2) only in that the term  $\gamma p(\text{div } \xi)^2$  does not appear in the integrand; it is replaced by the new term

$$\frac{1}{4\pi} \cdot \frac{m^2 B^2}{r^2} (\xi_r^2 + \xi_z^2).$$

The  $z$  dependence of the perturbations can be written in the form  $\exp(ikz)$  by virtue of the translational symmetry, and the component  $\xi_z$  will appear in  $\text{div } \xi_\perp$  in the form of a product with  $k$ . Hence, if  $k$  approaches infinity while  $k\xi_z$  remains fixed, the term  $m^2 \beta^2 \xi_z^2 / 4\pi r^2$  vanishes and we again obtain a quadratic form in two variables:  $\xi_r$  and  $\text{div } \xi_\perp$ . It is a simple matter to obtain the stability condition in this case:



$$-\frac{d \ln p}{d \ln r} < \frac{m^2}{\beta} \tag{4.5}$$

Since  $\gamma > 1$ , perturbations with  $m \geq 2$  do not lead to instability if (4.3) is satisfied. However, when  $\beta > 2\gamma/3$ , the  $m = 1$  mode, i.e., the inner portion of the pinch, is subject to a more stringent stability condition than that given in (4.3). It can be shown that, in this case, a kink ( $m = 1$ ) instability develops inside the pinch and that this leads to the appearance of a sausage instability ( $m = 0$ ) at the periphery.

Thus, when  $m = 1$  perturbations are taken into account, the distribution in (4.4) is found to be unstable. However, a current-carrying conductor located at the axis can be used to reduce  $\beta$  in an annular plasma distribution; then the plasma can be stabilized if the pressure does not fall off too rapidly with radius.

The condition in (4.4) also represents a limitation on the curvature of the pressure distribution. A pinch with a sharp boundary can develop perturbations for any  $m$ . The  $m = 1$  perturbation is essentially a kinking of the pinch, the instability arising as a consequence of compression of the lines of force at the concave side of the pinch and expansion at the convex side. At higher values of  $m$  the perturbed pinch assumes the form of a multistranded cable (Fig. 6). These modes can be unstable only if the pitch is small enough (i.e., if the ratio  $m/ka$  is small).

§ 5. Convective Instability of a Low-Pressure Plasma

Let us now consider the particular case of a low-pressure plasma ( $\beta \ll 1$ ). In this case, the stability criteria for  $m \neq 0$  perturbations can be neglected and (4.3) assumes the form

$$-\frac{d \ln p}{d \ln r} < 2\gamma \tag{5.1}$$

Thus, if  $B_z = 0$ , and the plasma pressure is much smaller than the magnetic pressure, the stability is determined completely by (5.1). It turns out that the condition in (5.1) is a particular case of a more general condition for

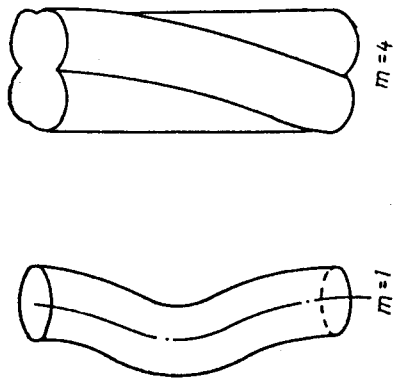

Fig. 6

convective stability in an arbitrary field with closed lines of force. Let us consider a single closed tube formed by the lines of force of the magnetic field and filled with plasma at a pressure  $p \ll B^2/8\pi$ . Since the plasma tries to expand, this tube will extend itself in such a way as to increase its volume. However, the motion of the tube is not free in a strong magnetic field: any appreciable curvature requires a large increase in magnetic energy and, hence, is not allowed. Only those displacements of the tube are allowed for which the magnetic field remains unchanged, i.e., the magnetic field at the final location of the tube must be essentially the same as the field at the initial location.

The volume of the force tube is  $V = \oint s dl$ , where  $s$  is the cross section of the tube and the integral is taken along the lines of force. But  $sB = \varphi$  is the magnetic flux within this tube and this flux must remain constant, both along the tube and in time, by virtue of the fact that the magnetic flux is frozen in in an ideal plasma. Hence,  $V = \varphi \oint \frac{dl}{B}$ , and the tube containing plasma will try to move in the direction in which the integral  $\oint \frac{dl}{B}$  increases. It could be said that a tube containing plasma in a magnetic field has a potential energy  $pU$ , where  $U = -\oint \frac{dl}{B}$ , and that the tube tries to move in the direction of lower  $U$ . By analogy with the case of an inhomogeneous fluid in a gravitational field we may conclude that the plasma can be in equilibrium only when the pressure is constant along a surface of constant  $U$ , i.e.,  $p = p(U)$ .

Let us now consider the stability of such an equilibrium plasma state. Assume that a tube containing plasma is displaced by an infinitesimally small amount, separating the remaining tubes in its displacement. If this displacement is convective, i.e., if it does not distort the magnetic field, the relative change in tube volume is  $\delta V/V = \delta U/U$ ; on the other hand, the change in pressure as a consequence of the adiabatic expansion is  $dp = -\gamma p \delta U/U$ . If the displacement occurs in the direction of increasing  $p(U + \delta U) = p + (dp/dU)\delta U$  and the pressure in the displaced tube is smaller than that of the plasma which surrounds it, the tube will be subject to a buoyant force and the expansion of the plasma will be unstable. On the other hand, if the pressure in the tube is higher, i.e., if  $-\gamma p(\delta U/U) > (dp/dU)\delta U$ , the tube will be expelled in the direction of equilibrium and the plasma will be stable. Thus, in a magnetic trap with closed lines of force the lines must satisfy the stability condition

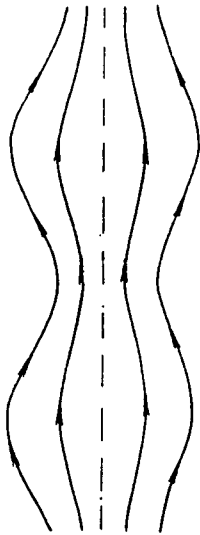

Fig. 7

$$\frac{dp}{dU} < \frac{\gamma p}{|U|}. \quad (5.2)$$

To summarize: stability does not necessarily mean that the pressure must diminish with increasing  $U$ . Stable states are also possible if the pressure increases with  $U$ , provided the rate of increase is not too rapid. This condition is completely analogous to the criterion for convective stability of an inhomogeneous compressible gas in a gravitational field. We now consider several particular cases.

a. Magnetic Field of a Straight Current. The field of a straight current falls off as  $r^{-1}$ , and the length of the lines of force is proportional to  $r$ ; hence,  $U$  falls off as  $r^{-2}$  with increasing distance from the conductor. The stability condition (5.2) is obviously the same as (5.1).

b. Point Dipole. The magnetic field of a point dipole can also be regarded as a magnetic trap. A natural trap of this kind is the magnetic field of the earth and the existence of ion belts around the earth is a direct demonstration of its efficiency.

We assume that the surface of the dipole is insulated so that the ends of the lines of force are not frozen in its surface. This will be the case, in particular, if the field is produced by circular currents of small dimensions. The plasma is then subject to convective instabilities and the instability condition is of the form in (5.2). Since the magnetic field of a dipole falls off as  $r^{-3}$ , while the length of the line of force is proportional to  $r$ , then  $U \sim r^{-4}$  and the stability condition assumes the form

$$-\frac{d \ln p}{d \ln r} < 4\gamma. \quad (5.3)$$

c. Bumpy Field. Let us now consider an axially symmetric periodic field with  $B_\phi = 0$ . The lines of force of this "bumpy" field are shown in Fig. 7. Each section of this field can be regarded as an individual magnetic mirror. Hence, the stability investigation carried out here can shed light on the

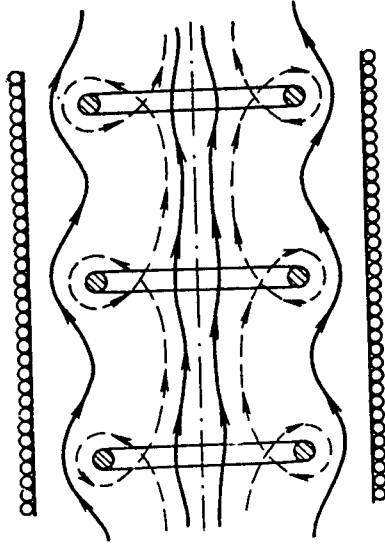

Fig. 8

stability of a plasma in a mirror device. In a bumpy field it is evident that the "potential energy"  $U$  falls off with  $r$  (i.e.,  $U$  increases in absolute magnitude with increasing distance from the axis of the system). Since there is no current flow in the trap, we have  $\int B dl = \text{const}$  and  $\int dl/B = \int (1/B^2) B dl$ , i.e.,  $|U|$  can be regarded as the mean value of  $(1/B)^2$ . But the mean value of the square of a quantity is always larger than the square of the mean value, so that

$$\int \frac{dl}{B} > \frac{\left(\int dl\right)^2}{\int B dl} = \text{const } l^2,$$

that is to say,  $|U|$  increases with the length of the line of force. It is evident from Fig. 7 that the lines of force become longer at greater distances from the axis of symmetry, so that  $U = -\int (dl/B)$  diminishes with increasing distance from the axis. It then follows that any plasma configuration is unstable in which the plasma pressure vanishes at some line of force; this result follows because  $p = 0$ , while  $dp/dU \neq 0$  at such points. In other words, a plasma in a bumpy field is generally unstable.

One further conclusion follows from our analysis. Since any increase in the inhomogeneity of the magnetic field caused by external conductors increases the length of peripheral lines of force, in general a plasma will tend to move in the direction of the inhomogeneity, that is to say, toward the external windings.

d. Multiply Connected Traps. In the final analysis, the convective instability of a plasma is a consequence of its diamagnetism, which tends to expel the plasma from a region of higher magnetic field. From the point of

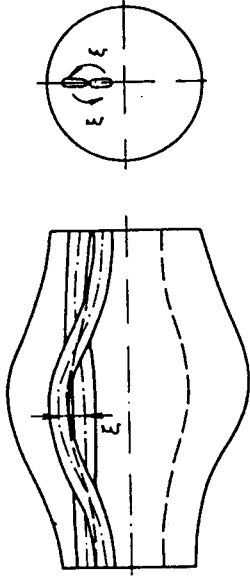

Fig. 10.

We shall again introduce a simple example: specifically, the field of a straight current. Assume that a cylindrically symmetric plasma column located in the field of a straight current is divided in half longitudinally along the z axis of an ideally conducting plane (Fig. 9). The displacement  $\xi$  is zero in this plane and hence  $m = 0$  perturbations are now allowed. This feature means that any perturbation must lead to deformation of the lines of force. However, as we have indicated above, the most dangerous perturbations are the interchange type, which are characterized by a minimum distortion of the magnetic field. As an approximation we can assume that these perturbations are  $m = 1$  perturbations, because the latter satisfy the condition  $\xi_{\perp} = 0$  at the boundary and have the smallest distorting effect on the lines of force. Since plasma flow through the divider is forbidden, in this case we can eliminate the possibility that  $\text{div } \xi$  vanishes. For this reason the potential energy expression will contain two stabilizing terms and an approximate stability criterion can be obtained by adding the right sides of the inequalities in (4.5) and (5.1). This criterion is of the form

$$-\frac{d \ln p}{d \ln r} < 2\gamma + \frac{1}{\beta}, \tag{6.1}$$

where

$$\beta = \frac{8\pi p}{B^2}.$$

The second term expresses the stabilizing effect of the conducting plane. In the case of perturbations with  $m \geq 2$ , as before we can use Eq. (4.5), because we have already chosen  $\xi_{\varphi}$  to make  $\text{div } \xi = 0$ .

A similar analysis can be carried out for more realistic systems. For example, let us consider a trap of length L with magnetic mirrors (Fig. 10). We are interested in a perturbation of the convective type, which corresponds

view of stability, one would then tend to prefer a trap in which the magnetic field increases (on the average) with increasing distance from the region occupied by plasma.

One trap of this kind is a periodic system (Fig. 8) consisting of a straight solenoid plus conducting rings, the current flow in the rings being in the opposite direction to that in the solenoid. In this configuration the field inhomogeneity is produced by the rings, so that plasma tubes close to the axis of symmetry and near the solenoid will be accelerated in the direction of the rings. Only those tubes which are located on the dashed lines of force passing through points at which the field vanishes will be stable; this result follows because U is equal to minus infinity on these lines. Since U increases in all directions going away from the dashed lines of force, any such distribution of low-pressure plasma in which the pressure falls off monotonically with increasing distance from these lines is known a priori. However, this trap has one important shortcoming in that the plasma occupies a multiply connected region surrounding the current rings, so that it is difficult to support these rings.

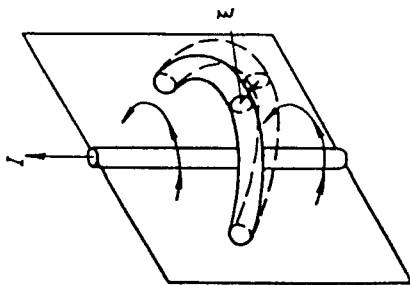

Fig. 9

### § 6. Stabilizing Effect of Conducting End Plates

The stability condition in (5.2) only holds for systems with closed lines of force. Such systems constitute a rather special narrow class because lines of force are generally not closed.

Let us consider the case in which the lines of force intersect a conductor of infinite conductivity. It should be kept in mind that the electron and ion velocity distributions must be highly anisotropic; if this were not the case, the particles would escape along the lines of force and recombine at the walls. However, in making a qualitative analysis we can regard the distribution as isotropic and use the hydrodynamic approximation assuming, however, that there is no recombination at the end electrodes and that the plasma pressure is constant along the lines of force, up to the walls. Here we shall make specific use of the hydrodynamic model and assume, in addition, that the plasma is in good electrical contact with the electrodes so that the ends of the lines of force can be assumed to be frozen in the conductor.

to the interchange of two tubes. These tubes cannot be interchanged completely, however, because they are anchored at the ends. Hence, the magnetic field is distorted and a restoring force arises as a consequence of the stretching of the lines of force. The most dangerous perturbations are those which result in the minimum field distortion. For this reason we consider the interchange of two ribbon-shaped tubes, since these tubes are only slightly bent in the azimuthal direction and thus give the minimum azimuthal perturbation of the field.

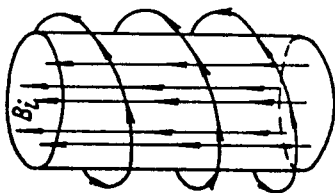

Fig. 11

The relative change in the volume of the tube in the convective perturbation is  $\text{div } \xi \approx \xi (\nabla U / U)$ , and the change in the magnetic field resulting from the bending of the lines is approximately  $B' \approx B(\partial \xi_r / \partial z) \approx (\pi/L) \xi_r B$ ; the perturbations we are considering are directed along the radius, i.e., along  $\xi$ . In this case the last term in the integrand in Eq. (2.7) can be neglected and we have approximately

$$W \approx \frac{1}{2} \int \left\{ \gamma p \left( \frac{\nabla U}{U} \right)^2 + \frac{\pi^2 B^2}{4\pi L^2} + \frac{\nabla p \nabla U}{U} \right\} \xi^2 d\tau. \tag{6.2}$$

Whence we obtain the stability condition

$$-\frac{\nabla p \nabla U}{U} < \gamma p \left( \frac{\nabla U}{U} \right)^2 + \frac{\pi B^2}{4L^2}. \tag{6.3}$$

In this expression the second term takes explicit account of the stabilizing effect of the conducting end plates.

For example, in a trap formed by a dipole and a conducting surface, using (6.3) we obtain the criterion

$$-r \frac{dp}{dr} < 4\gamma p + \frac{aB^2}{8\pi}, \tag{6.4}$$

where  $a$  is a numerical coefficient of order unity. The magnetic field of the earth can be regarded as a trap of this kind because the highly conducting ionosphere can be regarded as a solid ideal conductor to a high degree of accuracy.

### § 7. Surface-Layer Pinch in a Longitudinal Field

In all of the simple cases considered above, the stability condition was essentially a local expression. This is explained by the fact that the geometry (more precisely, the topology) of the systems that have been considered has

always been simple: parallel lines of force that remain parallel at large distances. Hence, the displacement of a tube in such a system was found to have an effect only on the nearby tubes, without affecting things at great distances. Generally, however, this picture does not hold and the stability criterion cannot be written in local form. It is possible to make an even stronger statement: with the exception of certain particular cases, the stability of a system cannot be determined by local conditions alone. Actually, the most dangerous perturbation is one for which  $W$  assumes a minimum value. Let us assume that of

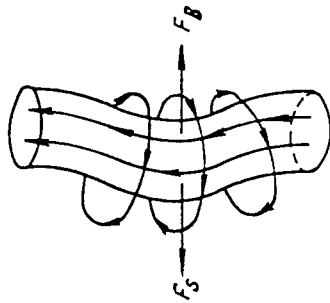

Fig. 12

this class of local perturbations we select the one which gives minimum  $W$ . If we now relinquish the local nature of the criterion and consider a more general class of perturbations, it is possible to find a smaller value of  $W$ , and hence, a more dangerous perturbation; consequently, the stability criterion certainly cannot be a local criterion.

In this section we shall be interested in the stability of a pinch with a longitudinal magnetic field. For reasons of simplicity, we assume that the pinch is a "skin" pinch, i.e., that all of the current flows in a thin surface sheet so that the pressure  $p$  and the longitudinal fields  $B_i$  and  $B_{ze}$  inside and outside of the pinch are independent of  $r$  (Fig. 11). In this example, we shall encounter a new stabilizing effect — shear in the lines of force.

We have shown in § 4 that a skin pinch without a longitudinal magnetic field is unstable. The presence of an internal longitudinal field has a marked effect on this result. If the field direction inside the pinch is not the same as the field direction outside the flute instability oriented along the outer lines of force tends to cause a strong distortion of the inner field. Hence, if the field is "frozen-in" the local perturbations cannot produce an instability.

A longitudinal field has precisely the same stabilizing influence on longwave perturbations. For example, consider a pinch with a frozen longitudinal field  $B_i \neq 0$  and assume that  $B_{ze} = 0$ . If the pinch is bent, the lines of force of the azimuthal field are crowded together inside the "bend" and extended outside. Consequently, the inside field pressure will be greater than the outside pressure and the equilibrating force  $F_S$  is directed outward. The stretching of the distorted lines of the longitudinal field produces a force  $F_B$  directed inward (Fig. 12). If  $F_B > F_S$ , the pinch is stabilized against this kink instability.

In our case (cylindrical symmetry) the field freezing condition (1.12) is written

$$i \left( kB_{ze} + \frac{m}{a} B_\phi \right) \xi_r(a) = Ck \frac{K'_m(ka)}{K_m(ka)}. \quad (7.5)$$

From the condition that Eqs. (7.3)-(7.5) be solvable with respect to C,  $\tilde{p}$  and  $\xi_r(\alpha)$ , we find the dispersion equation

$$4\pi Q_0 \omega^2 = B_i^2 k^2 - \left( kB_{ze} + \frac{m}{a} B_\phi \right)^2 \frac{I'_m(ka)}{I_m(ka)} \frac{K_m(ka)}{K'_m(ka)} - \frac{B_\phi^2 k}{a} \frac{I'_m(ka)}{I_m(ka)}. \quad (7.6)$$

In this expression the first term results from the stretching of the lines of force of the magnetic field inside the pinch. The second term, which is also positive since  $K_m/K'_m < 0$ , arises as a consequence of the stretching of the lines of force outside the pinch. This term is proportional to the square of the component of the wave vector in the direction of the external magnetic field and vanishes when  $kB = kB_{ze} + (m/a)B_\phi = 0$ , i.e., this term vanishes when the perturbation is constant along the lines of force of the external field. As we have seen earlier on the basis of physical considerations, in these perturbations the magnetic field outside the pinch is not distorted, so that it cannot stabilize the boundary. However, we note that the first term does not vanish, this being precisely the result of the shear of the lines of force.

Finally, we note that the last term in Eq. (7.6) is negative; it is this term which can give rise to the instability. If the origin of this term is traced, one finds that it arises from the second term in Eq. (7.4), i.e., in the final analysis this term is a result of the fact that the magnetic field diminishes with increasing distance from the pinch boundary.

Let us consider two particular cases.

a)  $B_{ze} = 0$ .

If  $B_{ze} = 0$ , we find for  $m = 0$  modes,

$$\omega^2 = \frac{B_i^2 k^2}{4\pi Q_0} \left\{ 1 - \frac{B_\phi^2}{B_i^2} \frac{I'_0(ka)}{ka I_0(ka)} \right\}.$$

The maximum value of  $I'_0(x)/xI_0(x)$  is  $1/2$ , so that the pinch is stable against the sausage instability if  $B_i^2 > B_\phi^2/2$ . However, the internal field does not give complete stability against the  $m = 1$  perturbation. For  $m = 1$ ,

Let us consider this effect in greater detail. Because of the cylindrical symmetry of the problem, the displacement  $\xi$  can be written in the form  $\xi(r) \exp\{im\varphi + ikz\}$ . If we limit ourselves to the case  $k \neq 0$ , it is always possible to choose  $\xi_z$  so as to make  $\text{div } \xi$  vanish, in which case the first term in the integrand of the potential energy also vanishes. Thus, from the point of view of pinch stability the plasma can be regarded as incompressible.

Making use of this fact, we consider a model problem in which the plasma is replaced by an incompressible fluid of the same density  $\rho_0$ . Obviously, the oscillation spectrum is changed by this substitution but the stability criterion is not.

Because the geometry of the problem is simple, the small-oscillation equation can be solved. By virtue of the fact that the fluid is incompressible,  $\mathbf{B}' = \text{rot}[\xi \mathbf{B}_i] = ikB_i \xi$ , and the small-oscillation equation reduces to the form

$$\left( -\omega^2 Q_0 + \frac{k^2 B_i^2}{4\pi} \right) \xi = -\nabla \tilde{p}, \quad (7.1)$$

where  $\tilde{p} = p + \mathbf{B} \mathbf{B}' / 4\pi$ . Then  $\Delta \tilde{p} = 0$ , since  $\text{div } \xi = 0$ , i.e.,

$$\tilde{p}(r) = \tilde{p}(a) \frac{I_m(kr)}{I_m(ka)}, \quad (7.2)$$

where  $a$  is the radius of the pinch. Using Eq. (7.1) we can easily find the displacement at the boundary  $\xi_r$ :

$$\xi_r(a) = \frac{4\pi k}{4\pi Q_0 \omega^2 - B_i^2 k^2} \tilde{p}(a) \frac{I'_m(ka)}{I_m(ka)}, \quad (7.3)$$

where  $I_m$  is a Bessel function of imaginary argument.

Outside of the pinch we have  $\text{rot } \mathbf{B}' = 0$  and  $\text{div } \mathbf{B}' = 0$ , i.e., we can write  $\mathbf{B}' = \nabla \psi$ , where  $\nabla^2 \psi = 0$ . The solution for  $\psi$  that remains bounded at infinity is of the form  $\psi = CK_m(kr)/K_m(ka)$ , where  $K_m$  is the MacDonald function and  $C = \text{const}$ .

We must now take account of the boundary conditions, namely the equality of the pressures and the normal components of the magnetic field at the surface of the pinch. Outside the plasma the magnetic field is made up of the longitudinal field  $B_{ze}$  and the azimuthal field  $B_\phi$ . Since  $B_{ze} = \text{const}$  while  $B_\phi \sim 1/r$ , then  $(\partial/\partial r)(B_{ze}^2 + B_\phi^2) = -2B_\phi^2/\alpha$  at the boundary, and the pressure condition (1.9) becomes

$$\tilde{p}(a) = \frac{i}{4\pi} \left( kB_{ze} + \frac{m}{a} B_\phi \right) C - \frac{B_\phi^2}{4\pi a} \xi_r(a). \quad (7.4)$$

$$4\pi Q_0 \omega^2 = B_i^2 k^2 + \frac{B_0^2 k}{a} \frac{I_1'(ka)}{I_1(ka)} \frac{K_0(ka)}{K_1'(ka)}$$

At long wavelengths, in which case  $ka \rightarrow 0$ , this expression becomes

$$\omega^2 = \frac{B_i^2 k^2}{4\pi Q_0} \left\{ 1 - \left( \frac{B_\varphi}{B_i} \right)^2 \ln \frac{1}{ka} \right\},$$

that is to say, the longwave perturbations are not stabilized even in the limiting case in which  $B_\varphi = B_i$ , so that  $p = 0$ . On the other hand, this instability can be stabilized by the presence of conducting walls located close to the pinch. The normal component of the field must vanish at the conducting wall, i.e.,  $\partial\psi/\partial r|_{r=b} = 0$ , and when this condition is taken into account the ratio  $K_m'(ka)/K_m(ka)$  in the second term on the right side of Eq. (7.6) is replaced by

$$\frac{K_m(ka) I_m'(kb) + I_m(ka) K_m'(kb)}{K_m'(ka) I_m'(kb) - I_m(ka) K_m'(kb)},$$

where  $b$  is the radius of the chamber.

An appropriate analysis shows that this pinch with a frozen-in longitudinal field will be stable if  $b < 5a$ .

b)  $B_{ze} \gg B_\varphi$ .

The addition of a small longitudinal field outside the pinch only deteriorates the stability because the second term in Eq. (7.6) can be reduced in this case. Hence, at the outset we shall consider the second limiting case, in which  $B_{ze} \gg B_\varphi$  outside the pinch. In this case, longwave perturbations characterized by  $ka \ll 1$  can lead to an instability. Let us assume that  $m$  is positive. At small  $ka$  we then find  $I_m'/I_m = m/ka$ ,  $K_m'/K_m = -m/ka$ , and Eq. (7.6) assumes the simpler form

$$4\pi Q_0 \omega^2 = k^2 B_i^2 + \left( kB_{ez} + \frac{m}{a} B_\varphi \right)^2 - \frac{m B_\varphi^2}{a^2}. \quad (7.7)$$

It is then an easy matter to find the minimum value  $\omega_{\min}^2$ . This value obtains when  $k(B_{ze}^2 + B_i^2) + (m/a)B_{ze}B_\varphi = 0$ , and is given by

$$\omega_{\min}^2 = \frac{B_\varphi^2}{4\pi Q_0 a^2} \left[ \frac{m^2 B_i^2}{B_{ze}^2 + B_i^2} - m \right]. \quad (7.8)$$

If  $B_i = B_{ze} = B_z$ , Eq. (7.8) shows that only the  $m = 1$  perturbation grows in time (the screw instability) and the pinch is stable against the remaining perturbations, characterized by  $m \geq 2$ .

Thus, an infinitely long pinch is unstable against the screw instability ( $m = 1$ ) for an arbitrarily large ratio  $B_z/B_\varphi$ . However, any real pinch will be of finite length, say  $L$ , so that  $k$  cannot be smaller than  $2\pi/L$ . When  $B_i = B_{ze} = B_z$ , it is evident from Eq. (7.7) that  $\omega^2$  is positive for  $|k| < B_\varphi/a B_z$ ; consequently, a pinch of finite length  $L$  is stable if

$$\frac{B_\varphi}{B_z} < \frac{2\pi a}{L}. \quad (7.9)$$

This condition, obtained independently by Shafranov and by Kruskal, is a necessary one for stability of a plasma pinch in a strong longitudinal field. It means that the pitch of the lines of force must be greater than  $L$ .

### § 8. Pinch with Distributed Current

The case treated in § 7 represents an extreme idealization. In reality, the skin depth cannot be infinitesimally thin for two reasons: 1) under actual conditions the current will exhibit a rather broad radial distribution, and, 2) even if the skin depth is small, it is always possible that there are perturbations whose wavelength is comparable with the skin depth.

The stability of a pinch with a distributed current can be investigated most conveniently by means of the energy principle. We shall assume that the plasma occupies the entire volume up to the conducting wall of radius  $b$ , so that the potential energy is given completely by the first integral in Eq. (2.7). By virtue of the cylindrical symmetry of the problem, the dependence of  $\xi$  on  $z$  and  $\varphi$  can be written in the form  $\exp(ikz + im\varphi)$ . In this case, the minimization of the potential energy with respect to  $\xi_\varphi$  and  $\xi_z$  can be carried out algebraically and yields

$$-\frac{m}{r} \xi_\varphi + k \xi_z = \frac{i}{r} \frac{d}{dr} (r \xi); \quad (8.1)$$

$$\xi_\varphi B_z - \xi_z B_\varphi = -\frac{ir}{k^2 r^2 + m^2} \left[ (kr B_\varphi - m B_z) \frac{d\xi}{dr} - (kr B_\varphi + m B_z) \frac{\xi}{r} \right], \quad (8.2)$$

where  $\xi \equiv \xi_r$  is the radial component of the displacement.

If this expression is substituted in Eq. (2.7), after an additional integration by parts the potential energy can be expressed completely in terms of the radial displacement  $\xi$  and assumes the form

$$W = \frac{\pi}{2} \int_0^b \left\{ f \left( \frac{d\xi}{dr} \right)^2 + g \xi^2 \right\} dr, \quad (8.3)$$

where

$$g = \frac{2k^2 r^2}{k^2 r^2 + m^2} \frac{dp}{dr} + \frac{1}{4\pi r} (krB_z + mB_\phi)^2 \frac{k^2 r^2 + m^2 - 1}{k^2 r^2 + m^2} + \frac{2k^2 r}{4\pi (k^2 r^2 + m^2)^2} (k^2 r^2 B_z^2 - m^2 B_\phi^2). \quad (8.4)$$

Minimizing Eq. (8.3) with respect to  $\xi$ , we obtain the Euler equation

$$\frac{d}{dr} \left( f \frac{d\xi}{dr} \right) - g\xi = 0 \quad (8.6)$$

with the following boundary conditions:  $\xi$  is finite for  $r = 0$  and vanishes for  $r = b$ .

Thus, the problem of determining the stability of a distributed-current pinch is reduced to the solution of a second-order differential equation (8.6). The stability condition can be formulated as follows: a necessary and sufficient condition for stability of a distributed-current pinch is that the solution of Eq. (8.6) have fewer than two zeros in the interval  $0 < r < b$ .

If we wish to solve the complete problem of finding the characteristic oscillations of the plasma, we must find an extremum of the Lagrangian  $L = T - W$  rather than the potential energy  $W$ ; hence, if  $\omega \neq 0$ , Eq. (8.5) for  $g$  will include an additional term which is positive when  $\omega^2 < 0$  and negative when  $\omega^2 > 0$ . Let us now assume that the solution of Eq. (8.6) has more than two zeros in the interval (0, b). Then, by adding a positive quantity to Eq. (8.5) we can shift the zeros and one of them will move to the point  $r = b$  and the other to the point  $r = 0$ . Since displacement of the zero to the singularity  $r = 0$  gives a solution that remains bounded for  $r = 0$ , both boundary conditions are satisfied and, consequently, the plasma will be unstable ( $\omega^2 < 0$ ). However, if there are fewer than two zeros in the interval (0, b), the boundary conditions can be satisfied only by a negative increment to the expression in (8.5), i.e.,  $\omega^2 > 0$ .

Let us now examine some of the consequences that follow from this general statement. We start with the stability condition with respect to a local perturbation, i.e., a very large azimuthal number  $m$ . If  $m$  and  $k$  both approach infinity but their ratio remains finite, the quantity  $f$  remains finite in all terms in Eq. (8.5), with the exception of the second. The second term is positive and approaches infinity when  $m \rightarrow \infty$ . Hence, when  $m \gg 1$ , an instability can only arise if this term is very small, i.e., near the point  $r = r_0$ ,

where  $krB_z + mB_\phi = 0$ . At this point the pitch of the helical line of force coincides exactly with the pitch of the perturbation, i.e., the perturbation is constant along the line of force. In other words, the perturbation is convective near the point  $r = r_0$ .

Now we introduce the quantity  $\mu = B_\phi / rB_z$ , which characterizes the pitch of the line of force, and write  $x = r - r_0$  to represent the distance from the point  $r_0$ . We assume that  $x$  is small, so that  $f$  and  $g$  can be expanded in powers of  $x$ ; only the first terms are retained. Assuming that  $krB_z + mB_\phi = mB_z \mu x$ , we have

$$f = \frac{r^2 B_z^4}{4\pi B^2} (\mu')^2 x^2; \quad g = \frac{2B_\phi^2}{B^2} \rho' + \frac{m^2 r B_z^2}{4\pi} (\mu')^2 x^2, \quad (8.7)$$

so that the Euler equation (8.6) becomes

$$\frac{d^2 \xi}{dx^2} + \frac{2}{x} \frac{d\xi}{dx} + \frac{q}{x^2} \xi = \kappa^2 \xi,$$

where

$$q = -\frac{8\pi \mu^2}{r (\mu')^2 B_z^2} \rho'; \quad \kappa^2 = \frac{m^2 B^2}{r^2 B_z^2}; \quad \mu' = \frac{d\mu}{dr};$$

$$\rho' = \frac{d\rho}{dr}.$$

If  $x \ll 1/\kappa \sim r/m$ , the right side of Eq. (8.6) can be neglected and in this region the solution is in the form of a power function  $\xi = x^\nu$ , where  $\nu = -1/q \pm \sqrt{1/4 - q}$ . If  $q < 1/4$ , the exponent  $\nu$  is real and the solution has no zeros. On the other hand, if  $q > 1/4$  the solution can be written in the form  $\xi = x^{-1/2} \sin(\sqrt{q - 1/4} \ln x)$  and thus exhibits an infinite number of zeros in the vicinity of the point  $x = 0$ . The general stability criterion indicates that the pinch is stable in a local sense only when  $q < 1/4$  or, in more explicit form, when

$$-8\pi r \frac{d\rho}{dr} < \frac{B_z^2}{4} \left( \frac{d \ln \mu}{d \ln r} \right)^2. \quad (8.8)$$

This condition on the convective stability of a current pinch was first given by Suydam.

It follows from (8.8) that any pressure distribution that diminishes in the radial direction is unstable if  $\mu = \text{const}$ . In particular, a pinch with a uniform longitudinal current is absolutely unstable if  $B_z = \text{const}$ .

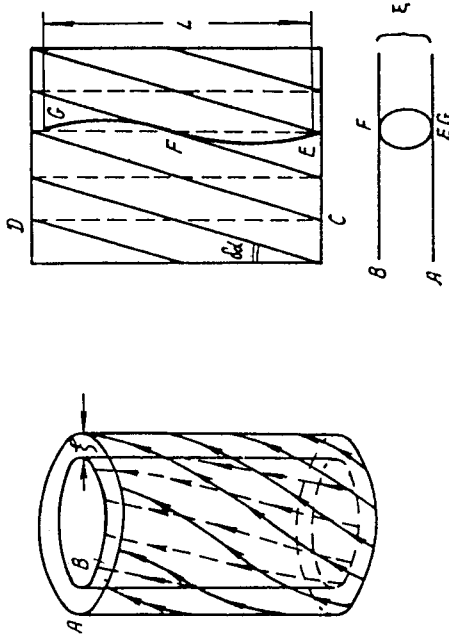

Fig. 13

occur inside the layer ( $x < 0$ ), i.e., only those perturbations contribute to the instability whose pitch is greater than the pitch of the lines of force.

This instability is related to the existence of an azimuthal field and represents a localized variant of the screw instability. It is evident from Eq. (8.9) that the instability is due to perturbations characterized by small  $m$ , and that the most dangerous mode is the  $m = 1$  mode (which cannot be treated by our local analysis).

The Suydam condition is only a necessary condition since it refers only to a localized perturbation ( $m \gg 1$ ). Some perturbations with small  $m$  are not localized and the appropriate stability condition cannot be a local one.

Let us first consider  $m = 0$  perturbations. It follows from Eq. (8.5), which governs the quantity  $g$ , that the most dangerous perturbation is the one for which  $k \rightarrow 0$ ; for this perturbation,

$$W_{m=0} = \frac{\pi}{2} \int_0^b \left( \frac{rB_z^2}{4\pi} \left( \frac{d\xi}{dr} \right)^2 + 2 \frac{dp}{dr} \xi^2 + \frac{B^2}{4\pi} \xi^2 \right) dr.$$

It is evident that the pinch is stable with respect to the sausage instability ( $m = 0$ ) if the ratio  $8\pi p/B^2$  is small enough.

Let us now assume that  $m \neq 0$ . Since  $k$  can assume arbitrary values in an infinite pinch, we can write  $k = qm$ . Then  $m$  disappears everywhere except in the second term in Eq. (8.5); since this term is positive, it follows immediately that the most dangerous perturbation is the one for which  $m = 1$ .

If  $\mu = \text{const}$ , the pitch of the lines of force  $l = 2\pi/\mu$  is independent of radius and two lines separated by any radial distance can be interchanged without appreciable distortion of the magnetic field. Under these conditions the convective instability is not forbidden in any way. However, free interchange of the tubes is not possible if  $\mu$  varies with  $r$ . For example, let us consider two magnetic surfaces  $A$  and  $B$  separated from each other by a small distance. In Fig. 13, the surfaces are shown as planes, and points characterized by the same value of the azimuth angle lie above each other. The lines of force on surface  $A$  are shown by dotted lines and those on surface  $B$  are shown by solid lines. If  $\mu \neq \text{const}$ , these lines exhibit a shear with respect to each other: they form an angle  $\delta\alpha$  proportional to  $\xi r \mu'$  [more precisely,  $\delta\alpha = (B_z^2/B^2) r \mu' \xi$ ]. Hence, interchange of a very long tube, for example  $CD$ , from plane  $B$  will cause a strong distortion of the magnetic field close to the surface  $B$ . The perturbation which produces the minimum distortion of the magnetic field will be one for which the displaced force tube makes the smallest possible angle with the lines of force. For example, if the displacement is a kinking of the tube  $EFG$ , with the anchored ends  $EG$ , the displaced tube must assume the shape of one turn of a helical spiral with pitch  $L = 2\pi \xi / \delta\alpha = 2\pi B^2 / B_z^2 r \mu'$  (cf. Fig. 13).

Thus, shearing of the lines of force produces the same stabilizing effect as conducting endplates (cf. § 6); shear effectively limits the length of the convectively interchanged tubes to the value  $L \approx 2\pi B^2 / B_z^2 r \mu'$ .

Let us now assume that  $dp/dr \approx 0$  at some value of  $r$ . In this case, we must, in  $g$ , in Eq. (8.5) take account of higher-order quantities in  $x$ ; as an approximation we write

$$g = -\frac{1}{4\pi} \frac{B^3 B_z^3}{B^4} 4\mu' x + \frac{m^2 r B_z^2}{4\pi} (\mu')^2 x^2.$$

The Euler equation then becomes

$$\frac{1}{x^2} \frac{d}{dx} \left( x^2 \frac{d\xi}{dx} \right) + \frac{4\mu}{r^2 \mu'} \frac{B^2}{B^2} \frac{\xi}{x} = \kappa^2 \xi = \frac{m^2 B^2}{r^2 B_z^2} \xi, \tag{8.9}$$

which is analogous to the Schrödinger equation for the hydrogen atom. The stability criterion is then analogous to the criterion for the absence of a bound state, i.e.,

$$\frac{B^4 B_z^2}{B^6} < \frac{m^2}{4} \left( \frac{d \ln \mu}{d \ln r} \right)^2.$$

Equations (8.9) show that when  $\mu' / \mu > 0$  the instability can only occur outside the surface  $x = 0$ ; similarly, when  $\mu' / \mu < 0$ , the instability can only



Integrating the potential energy by parts (8.3), we find

$$W = \frac{\pi}{2} \int_0^b \left[ \frac{1}{k^2 r^2 + m^2} \left[ (krB_z + mB_\phi) \frac{d\xi}{dr} + (krB_z - mB_\phi) \frac{\xi}{r} \right]^2 + \right. \\ \left. + \left[ (krB_z + mB_\phi)^2 - 2B_\phi \frac{d}{dr} (rB_\phi) \right] \frac{\xi^2}{r^2} \right] r dr.$$

It then follows that a pinch in which  $B_\phi$  falls off faster than  $r^{-1}$  in the radial direction is stable against any perturbation. However, this distribution can only be produced by means of a metal current-carrying conductor at the center of the pinch.

This result, generally speaking, is all that can be obtained from our general analysis. In order to go beyond this point, it is necessary to solve the Euler equation (8.6) for each particular case. It is possible to find certain stable distributions of fields and currents in this way, but this question is rather special and goes beyond the framework of the present review. We shall confine ourselves here to consideration of the very simple case of a thin skin layer.

In §7 we have considered the stability of a sheet pinch in the approximation in which the thickness of the sheet is vanishingly small. Actually, however, the skin depth is of finite thickness  $\delta$ , and the transition to the limit  $\delta \rightarrow 0$  is not completely trivial.

When  $\delta \ll a$ , the Suydam condition is easily satisfied since the left side of Eq. (8.8),  $\sim 1/\delta$ , while the right side  $\sim 1/\delta^2$ . Thus, the sheet is stable locally, i.e., with respect to perturbations with transverse wavelength  $\lambda_\perp \sim a/m \lesssim \delta$ , and it is only necessary to consider perturbations with  $m \ll a/\delta$ . When  $\delta \ll a$ , we only need solutions outside the pinch and inside the pinch, treating the sheet itself in the form of a connecting condition. We assume that  $B_\phi = 0$  inside the pinch; in this case the solution of the Euler equation (for the inner part) which remains bounded for  $r = 0$  is

$$\xi = I_m(kr), \quad (8.10)$$

where  $I_m$  is the Bessel function with imaginary argument.

If there is no conducting wall ( $b = \infty$ ), the solution of Eq. (8.8) for the region outside the pinch, where  $p = 0$ , is

$$\xi = \frac{kr}{krB_{ze} + \frac{ma}{r} B_\phi} K'_m(kr), \quad (8.11)$$

where  $K_m$  is the MacDonald function of index  $m$ .

When  $m \ll a/\delta$ , we need only retain the first term in the expression for  $g$  inside the sheet, i.e., as an approximation we have

$$g = \frac{2k^2 a^2}{k^2 a^2 + m^2} \frac{dp}{dr}. \quad (8.12)$$

We first consider the perturbations for which  $f$  does not vanish inside the sheet. In this case,  $\xi$  can be regarded as constant inside the thin sheet. Integrating Eq. (8.6) across the sheet, we find the connection condition:

$$\left( f \frac{\xi'}{\xi} \right)_e - \left( f \frac{\xi'}{\xi} \right)_i = - \frac{2k^2 a^2}{k^2 a^2 + m^2} p, \quad (8.13)$$

where the subscripts  $e$  and  $i$  mean that a given quantity is taken outside or inside the pinch, respectively.

If the solutions (8.10) and (8.11) are substituted in Eq. (8.13), and if the left side is smaller than the right side, the solution satisfying the connection condition (8.13) will have fewer than two zeros and the pinch is stable. However, if the left side is larger than the right side, a solution satisfying (8.13) will have at least two zeros in the range  $0 < r < \infty$ , and will be unstable, in accordance with our general criterion. Thus, the stability criterion for the pinch is obtained by substituting (8.10) or (8.11) in (8.13) and replacing the equality sign by the  $<$  symbol. This criterion is

$$- \left( kB_e + \frac{m}{a} B_\phi \right)^2 \frac{K'_m(ka)}{K_m(ka)} + k^2 B_e^2 I_m(ka) - \frac{k}{a} B_\phi^2 > 0 \quad (8.14)$$

and is evidently exactly the same as (7.6).

Let us assume now that  $f$  vanishes at some point  $r = r_s$  within the sheet. We shall show, first of all, that the singularity at this point is sufficiently strong so that the solutions to the left and to the right are completely independent.

Near the singularity the Euler equation (8.7) can be written

$$\psi'' + \frac{q}{x^2} \psi = 0,$$

where  $\psi = \xi x$ , i.e., this equation is in the form of a Schrödinger equation with potential  $U_1 = -q/x^2$ . If we take account of inertia ( $\omega \neq 0$ ), the potential well will have a "bottom" so that the function  $U_1$  can be taken as constant when  $|x| < x_0$ . Even  $\psi_e$  and odd  $\psi_0$  solutions in this region are, respectively,  $\psi_e = \cos(\sqrt{qx}/x_0)$  and  $\psi_0 = \sin(\sqrt{qx}/x_0)$ . The solution for  $x > x_0$

where  $B_{zs}$  and  $B_{\phi s}$  are the field values at the singularity.

In exactly the same way, by integrating Eq. (8.6) from  $r_s$  to  $r_0$ , we obtain the second condition:

$$-\left(kB_\epsilon + \frac{m}{a} B_\phi\right)^2 \frac{K_m(ka)}{K'_m(ka)} + \frac{k^2 a}{k^2 a^2 + m^2} (B_{zs}^2 + B_{\phi s}^2) - \frac{k}{a} B_\epsilon^2 > 0. \tag{8.16}$$

Taken together, the two conditions (8.15) and (8.16) represent a more stringent condition than the single condition (8.14). This is explained by the fact that it is impossible to impose a connection condition on  $\xi$  from both sides of the sheet because the perturbation has a singularity within the sheet. For this reason, the condition (8.14), which is obtained under the assumption that  $\xi$  is continuous, is a weaker condition.

Let us now consider the particular case  $B_z = \text{const}$ ,  $B_\phi/B_z \ll 1$ . In this case we can assume that  $ka \ll m$  and two very simple conditions are derived from (8.15) and (8.16):

$$1 - \frac{1}{m} \left(1 + \frac{B_{\phi s}^2}{B_z^2}\right) > 0; \tag{8.17}$$

$$\left(kB_z + \frac{m}{a} B_\phi\right)^2 + \frac{k^2}{m} B_z^2 - \frac{m}{a^2} B_\phi^2 > 0. \tag{8.18}$$

It is then obvious that the external portion of the sheet is unstable for all  $m$ , while the inner portion is weakly unstable only for  $m = 1$ . The unstable nature of the outer layer of the sheet is due to the last term in Eq. (8.18). In the final analysis, the instability is due to the reduction in azimuthal field as a function of distance from the boundary of the pinch; in other words, the jump in current density. Hence, this instability can also arise when the current is distributed over the entire pinch. According to Eqs. (8.1) and (8.2),  $\xi_\phi/\xi_r$  and  $\xi_z/\xi_r$  approach infinity close to the singularity  $r = r_s$ , so that this instability is expressed in the fact that the thin surface layer of the pinch tries to form a helical "braid."

It is evident from this example that any kind of singularity in the current distribution requires a special analysis, and that satisfaction of the Suydam condition is not sufficient for stability of such discontinuities.

In concluding this portion of the review, we wish to consider another question of qualitative nature concerning the difference between a vacuum plasma and a force-free plasma. In the last example we have not assumed

is of the form  $\psi = Ax^{\nu_1} + Bx^{\nu_2}$  where  $\nu_1 = 1/2 + \sqrt{1/4 - q}$  and  $\nu_2 = 1/2 - \sqrt{1/4 - q}$ , so that  $\nu_1 > \nu_2$ . The coefficients  $A$  and  $B$  can be found from the connection conditions on the logarithmic derivatives at  $x = x_0$ :

$$\frac{\nu_1 A x_0^{\nu_1-1} + \nu_2 B x_0^{\nu_2-1}}{A x_0^{\nu_1} + B x_0^{\nu_2}} = -\frac{\sqrt{q}}{x_0} \operatorname{tg} \sqrt{q};$$

$$\frac{\nu_1 A x_0^{\nu_1-1} + \nu_2 B x_0^{\nu_2-1}}{A x_0^{\nu_1} + B x_0^{\nu_2}} = \frac{\sqrt{q}}{x_0} \operatorname{cig} \sqrt{q}.$$

From these conditions we have:

$$\frac{B_\epsilon}{A_\epsilon} = -\frac{\nu_1 + \sqrt{q} \operatorname{tg} \sqrt{q}}{\nu_2 + \sqrt{q} \operatorname{tg} \sqrt{q}} x_0^{\nu_1 - \nu_2};$$

$$\frac{B_0}{A_0} = -\frac{\nu_1 - \sqrt{q} \operatorname{cig} \sqrt{q}}{\nu_2 - \sqrt{q} \operatorname{cig} \sqrt{q}} x_0^{\nu_1 - \nu_2}.$$

Since  $\nu_1 > \nu_2$ , it follows that  $B \rightarrow 0$  when  $x_0 \rightarrow 0$ , i.e., in the limit  $\omega \rightarrow 0$  both the odd and even solutions go as  $\xi = x^\alpha$ , where  $\alpha = -1/2 + \sqrt{1/4 - q}$ . Let us take half the sum and half the difference of these solutions: we then find that one of the two independent solutions of the Euler equation vanishes when  $x < 0$ , going as  $x^\alpha$  when  $x > 0$ , and that the other vanishes when  $x > 0$ , becoming  $|x|^\alpha$  when  $x < 0$ . Thus, the solutions on the two sides of the singularity are completely independent and the stability condition splits up into two conditions.

We now integrate Eq. (8.6) once with respect to  $r$  from the inner boundary of the sheet  $r = r_0$  to the singularity. Since  $f = 0$  when  $r = r_s$ , we find

$$-\left(f \frac{d\xi}{dr}\right)_i = \int_{r_0}^{r_s} g \xi dr \cong \xi_i \int_{r_0}^{r_s} g dr,$$

where we have taken  $\xi$  out from under the integral sign; this procedure is valid because  $\alpha$  is small when  $q \ll 1$  and  $\xi = x^\alpha$  for almost all values of  $x$ . Taking account of the equilibrium condition  $8\pi p + B_z^2 + B_\phi^2 = \text{const}$  inside the sheet, we can obtain one of these stability conditions from the solutions (8.10) and (8.11):

$$B_{zi}^2 \frac{I_m(ka)}{I'_m(ka)} - \frac{ka}{k^2 a^2 + m^2} (B_{zs}^2 + B_{\phi s}^2) > 0, \tag{8.15}$$

into a torus). In the second equilibrium state this flux is given by  $\Phi_1 = \pi r_0^2 B_z L / l$ , where  $l$  is the pitch of the helical line; for perturbations with the maximum growth rate the pitch is found from the condition  $2\pi/l = k = (1/a) \times (B_\phi / B_z)$ . Equating  $\Phi_0$  and  $\Phi_1$ , we find

$$r_0 = \sqrt{\frac{2l}{\pi c B_0} \ln \frac{b}{a}} = a \sqrt{2 \ln \frac{b}{a}} \quad (9.2)$$

This state is not completely an equilibrium state: the lines of force of the longitudinal field tend to smooth the fluid conductor, first forming it into a helical ribbon and then into a thin-walled cylindrical tube of the same radius  $r_0$ . In a straight pinch this final equilibrium state is obviously a neutral condition, since the field is everywhere uniform. In toroidal geometry, however, equilibrium is not possible without the longitudinal current and the fluid will move toward the outer wall as long as an equilibrium state is not reached.

The motion we have been describing is actually an imaginary motion which would occur if the pinch were located in a medium of high viscosity. Actually, however, the pinch will have a high radial velocity when it reaches the second equilibrium state, since all of the energy of the azimuthal field has been converted into kinetic energy. For this reason, the process becomes oscillatory. Nonetheless, the fact still remains that the screw instability arises as a consequence of the stretching of the lines of force, which try to annihilate the azimuthal field. Since this effect overcomes the infinite conductivity, the pinch is distorted into a helix.

In the second equilibrium state there is no azimuthal magnetic field and the field energy assumes the minimum possible value. It should be noted that this stable state is possible for any  $l$ , but that the perturbations can grow only when  $l \geq \pi B_z a / B_\phi$ . The transition to the minimum energy state requires the overcoming of a potential barrier for smaller values of  $l$ ; consequently this transition is not possible for small initial perturbations and infinite conductivity.

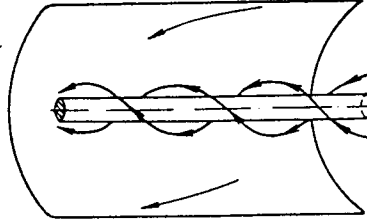

Fig. 14

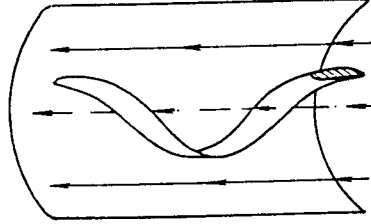

Fig. 15

that the region outside of the pinch is necessarily a vacuum, but have only stipulated zero plasma pressure in this region. We might call such a plasma a "zero-pressure" plasma. The following question then arises: Is a zero-pressure plasma always equivalent to a vacuum? The answer to this question is negative. A zero-pressure plasma can be regarded as a vacuum only if there are no singularities within the region, i.e., if the pitch of the perturbation nowhere coincides with the pitch of the line of force. If this condition does not hold, and if  $f$  vanishes at some point  $r = r_s$ , then, as we have seen earlier, the solution for  $\xi$  at this point must vary like a power series with a small exponent. But this behavior of the solution implies that  $\xi$  vanishes at a point close to the singularity. The singularity  $r = r_s$  is then equivalent to a conducting wall of radius  $b = r_s$ ; consequently, an ideally conducting plasma with zero pressure outside the pinch can have a stabilizing effect on certain perturbations.

§ 9. Screw Instability

In view of the particular importance of the  $m = 1$  perturbations, which are the most dangerous from the point of view of stability, it is desirable to consider in greater detail the physical nature of this instability, which we will call the screw instability.

Consider a thin ideally conducting pinch of radius  $a$  with current  $I$  flowing along its surface which is located in a uniform magnetic field  $B_z$  (Fig. 14). For simplicity we assume that this pinch is an incompressible fluid and that there is no magnetic field inside the pinch. We also assume that  $B_\phi = 2I/ca \ll B_z$ . Then, as follows from Eq. (7.7), the frequency of the  $m = 1$  oscillations is given by

$$4\pi Q_0 \omega^2 = \left( k B_z + \frac{1}{a} B_\phi \right)^2 - \frac{B_\phi^2}{a^2} \quad (9.1)$$

The largest growth rate is thus to be associated with the perturbation for which  $k = -(1/a)(B_\phi / B_z)$ . As long as it is small, this perturbation is constant along the lines of force and does not perturb the external field. We now wish to determine what happens in the subsequent growth in the perturbation.

Obviously, the pinch will be subject to an accelerating force until the magnetic field becomes uniform (Fig. 15). The radius of the equilibrium helix  $r_0$  can be found from the flux conservation condition as applied to the flux trapped by the ideal conductor. In the initial state, the flux trapped by the conductor is  $\Phi_0 = L(2l/c) \ln(b/a)$ , where  $b$  is the radius of the ideally conducting wall and  $L$  is the length of the entire system (which can be bent

We first consider an ordinary circular torus. We denote the minor radius of the pinch by  $a$  and the radius of curvature by  $R$ ;  $R$  is then the major radius of the torus. The quantity  $\varepsilon = a/R$  is rather small, about  $1/3$ , even in a highly curved torus, so that it is natural to use the quantity  $\varepsilon$  as the small expansion parameter. In the first approximation in  $\varepsilon$  all of the stability conditions remain unchanged and the only difference, as compared with the straight pinch, is the fact that the pinch is bounded in length, so that the longitudinal wave number  $k$  can only assume discrete values:  $k = 2/L_0 n = n/R$ , where  $L_0 = 2\pi R$  is the length of one circuit around the system, and  $n$  is an integer. In a system with a strong longitudinal field, this condition reduces to the Kruskal-Shafranov condition (7.9), i.e., to the absence of a screw instability.

It is found that this condition must be modified in systems in which the magnetic axis is not a plane curve, but exhibits finite curvature. These systems (the simplest example being a stellarator in the figure-eight configuration) are characterized by a so-called rotational transform, i.e., even in the absence of a longitudinal current the lines of force turn through some angle  $\alpha$  in making a complete circuit around the system. This means that points with the coordinates  $(z + L_0, \varphi)$  and  $(z, \varphi + \alpha)$  actually represent the same point in space and the phases of perturbations of the form  $\exp(ikz + im\varphi)$  must differ by an amount which is a multiple of  $2\pi$  at these points; similarly, the wave number  $k$  must satisfy the condition

$$kL_0 - m\alpha = -2\pi n. \quad (10.1)$$

Assume that  $B_\varphi$  is positive and that  $m = 1$ . Then, according to (7.7), a sheet pinch will be stable if  $-kB_z > B_\varphi/a$ . Substituting  $k$  from (10.1), we find the condition for helical stability of a current-carrying pinch current in a system in which  $\alpha \neq 0$ :

$$B_\varphi < \frac{a}{L} B_z (-\alpha + 2\pi n), \quad (10.2)$$

where  $n$  is the integer for which the right side of the inequality (10.2) assumes its smallest positive value. It is found that this condition is not limited to the case of a sheet pinch, but is valid for any radial current distribution.

When  $\alpha \neq (2q + 1)\pi$ , where  $q$  is an integer, it follows from (10.2) that the limiting currents are different for flow along the field ( $B_z/B_\varphi > 0$ ) and against the field ( $B_z/B_\varphi < 0$ ). Furthermore, it also follows from this condition that the limiting current against the field is small for small  $\alpha > 0$  ( $n = 0$ ).

Now let us assume that there is a trapped magnetic field inside the pinch. As we have seen in § 7, a pinch of infinite length is unstable in this case and will tend to be formed into a helix. However, the longitudinal field inside the pinch exerts a tension so that the equilibrium radius  $r_0$  is somewhat smaller under these conditions for the same pitch. Moreover, because of the trapped field the azimuthal field does not vanish completely.

Thus, the screw instability arises as a result of the stretching of the lines of force of the magnetic field, which try to become straight. This effect is clearly demonstrated in the  $m = 1$  screw instability, but this mode can easily develop into the  $m \geq 2$  mode. We have shown above that this transition will occur if the shear of the lines of force is small, i.e., if  $\mu' \approx 0$ .

### § 10. Stability of Toroidal Systems

Toroidal systems are of very great interest from the point of view of containment of high-temperature plasma by a magnetic field. By toroidal, here, we mean any system which is topologically equivalent to a torus: this can be a simple circular torus, a stellarator with a figure-eight configuration, a stellarator with helical stabilizing windings, or any other more complicated system which can be continuously transformed into a torus.

Obviously, the exact analysis of the stability of a plasma in systems of this kind is a problem of enormous mathematical difficulty; this is especially true because the absence of axial symmetry with respect to the magnetic axis of the system means that modes with different  $m$  cannot be separated, and the problem cannot be reduced to a one-dimensional problem. In the present state of research on stability, one is not basically interested in an exact investigation of a particular plasma distribution in a specified magnetic field; rather, one is interested in the general qualitative question of which fields are the most useful from the point of view of stability, and what a change in a given field configuration implies as far as stability is concerned. These qualitative considerations can be derived from a variational principle by appropriate choice of certain test functions for the perturbations; sometimes the required information can be obtained rather simply from direct consideration of the change in potential energy for small perturbations.

In the final analysis, the plasma instability in toroidal systems with longitudinal currents is essentially a combination of the screw and convective instabilities that we have already considered and the corresponding stability conditions are similar to those that have been obtained for the cylindrical pinch.

oscillations can appear and the frequencies of shortwave perturbations can be modified. We shall consider one example of this kind.

We start with the simplest possible case.

Assume that a current  $I_0$  flows in a thin conductor of radius  $a$  and density  $\rho_0$ , and that the conductor is located in a uniform magnetic field  $B_z$ . If the conductivity is infinite, this conductor is unstable against kinking and will assume a helical shape at a growth rate given by  $\omega^2 \approx B_z^2 / 4\pi a^2 \rho_0$ . We assume now that the conductivity is low and that the magnetic field is not trapped. Then, while being distorted into a helix the conductor is subject to a Lorentz force  $(1/c)I_0 B_z$ , where  $I_0 = k\xi I_0$  is the azimuthal component of the current and  $\xi$  is the radial displacement. Thus, we have  $\omega^2 = kI_0 B_z / c\pi a^2 \rho_0 = ka B_z B_z (2\pi \rho_0 a^2)^{-1}$ . When  $ka \sim 1$ , the growth rate is  $\sqrt{B_z^2 / B_z} \phi$  times greater than when  $\sigma = \infty$ . In other words, when  $\sigma = \infty$  the pinch is unstable only against longwave perturbations, for which  $ka \sim B_z / B_z \ll 1$ ; at low conductivities, however, the barrier against shortwave perturbations is removed and increasing the longitudinal field can even enhance the instability.

If the conductivity is large, but finite, the magnetic field is almost frozen in the plasma and the instability can only develop in the form of shortwave perturbations; the motion of the plasma, under these conditions, will be of the nature of a diffusion "leakage" across the lines of force. Since inertia does not play any role in this slow motion, the charged particles move at the drift velocity. Let us assume that the ion and electron pressures are small and that the magnetic field is uniform. In this case the only agency capable of producing a drift is the electric field and the electron and ion drift velocities are the same,  $\mathbf{v} = c[\mathbf{E}B] \cdot B^{-2}$ . We now show that this drift leads to an instability of the convective type in the presence of a longitudinal current and a nonuniform conductivity.

Assume that a current  $j_0$  flows along a uniform magnetic field  $B_z$  in the  $z$  direction; the current is so weak that the magnetic field it produces  $B_\phi \ll B_z$ . We also assume that in the equilibrium state the plasma conductivity  $\sigma_0$  is a slowly varying function of  $x$ . In a fully ionized plasma, in which the conductivity depends only on the electron temperature, this variation can be due to a temperature variation; in a weakly ionized plasma the gradient of  $\sigma_0$  can also arise as a consequence of a density gradient.

Now assume that this equilibrium state is subject to small perturbations. The semiclassical approximation can be used for shortwave perturbations and the dependence on coordinates and time can be expressed in the form  $\exp(-i\omega t + ikx)$ . We also assume that the longitudinal magnetic field is very

When  $|\alpha| < \pi$ , the condition in (10.2) remains approximately the same as when the rotational transform is produced by means of auxiliary helical windings. However, this statement may not hold if  $|\alpha| > \pi$ . For example, assume that the stabilizing winding is an  $l=3$  winding; in the case  $\alpha B_\phi / B_z > 0$ , i.e., when the rotation of the lines of force caused by the longitudinal current is of the same sign as in the case of the stabilizing windings, the pinch is found to be stable with respect to kinking when  $|B_\phi / B_z| \cdot I_0 / a < |\alpha|$ .

Now let us consider the helical instability of the pinch ( $m = 1$ ). Perturbations with  $m \gg 1$  can be reduced to a convective instability. In a weakly curved smooth pinch the convective instability rises when the Suydam condition (8.8) is violated. However, if the primary magnetic field is not uniform (i.e., if there are stabilizing helical fields), this condition is modified. We now write the Suydam condition in a form which shows its physical content more directly:

$$-\frac{2}{R_s} \frac{dp}{dr} < \frac{\pi B^2}{4L^2} \quad (10.3)$$

Here,  $R_s = rB_\phi^2 / B^2$  is the radius of curvature of the line of force, while  $L = 2\pi B / B_z r \mu'$  is the minimum possible wavelength of the perturbation along the line of force. In this form this condition is completely analogous to (6.3), so that the right side of (10.3) expresses the stabilizing effect of the shear of the lines of force. In the absence of a longitudinal current the quantity  $\mu'$  in the expression for  $L$  is to be replaced by  $\alpha' / L_0$ , where  $\alpha$  is the rotational transform computed for a complete circuit  $L_0$ . This procedure yields the following criterion for convective stability in a stellerator system with stabilizing windings:

$$-\frac{2}{R_s} \frac{dp}{dr} < \frac{B_z^2}{16\pi} \frac{r^2}{L_0^2} (\alpha')^2 \quad (10.4)$$

In a highly modulated field, the quantity  $2/R_s \sim U'/U$  can be of the order of  $1/r$ ; the rotational transform angle per unit length  $\alpha'/L_0$  can also be rather large, and it then follows from (10.4) that a low-pressure plasma ( $\beta = 8\pi p / B^2 \ll 1$ ) will be stable in this "shear" field ( $\alpha' \neq 0$ ).

### § 11. Current Convective Instability

Up to this point we have assumed in all cases that the plasma conductivity is infinite. If the conductivity is high but not infinite, all of the relations given above hold for perturbations characterized by long wavelengths and high frequencies. Furthermore, when  $\sigma \neq \infty$  new kinds of slow

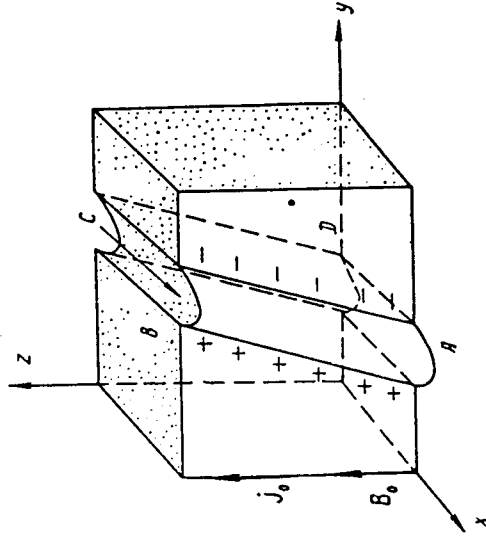

Fig. 16

growth rate is a maximum, we must take account of the inertia terms in the equations of motion and in Ohm's law. An analysis of this kind for a plane layer in a gravitational field has been carried out in [34]. It is shown there that the current convective instability is not the only possibility. An inhomogeneous plasma with finite conductivity is also subject to an instability of the "local pinch" type, which develops as a consequence of the tendency toward filamentation of the current flow, and to an instability of the convective ("gravitational") type which arises because the lines of force in a finite-conductivity plasma are not frozen in, so that the convective instability criterion becomes much more stringent. In particular, the inverted pinch (i.e., a concentric discharge in which the current rotates about a center conductor located at the axis of the discharge) is completely stable for ideal conductivity because  $d/dr(rB_\phi) < 0$ . However, Rebut has shown [35] that if the conductivity is finite this configuration becomes unstable if the current density exceeds some critical value which is smaller, the thinner the discharge. This result has been verified experimentally.

§ 12. Superheating Instability

There is another instability that is to be associated with the finite conductivity of a plasma; this instability can arise in Joule heating (by virtue of current flow) of a plasma in which the electrical conductivity increases with temperature. This instability arises because overheating of a plasma tube

strong and that the frequency of the Alfvén waves  $k_{zCA} = k_z B_0 (4\pi\rho_0)^{-1/2}$  is much higher than the frequency of the oscillations being considered here. In this case the perturbation of the magnetic field will be negligibly small and the electric field associated with the oscillations is irrotational:  $\mathbf{E} = -\nabla\varphi$ .

The transverse velocities of the electrons and ions are the same in the approximation being used here; hence, there is no transverse electric field and the perturbation of the longitudinal current must vanish, i.e.,

$$-ik_z\varphi\sigma_0 + \sigma E_0 = 0. \tag{11.1}$$

Drift in the transverse electric field leads to transport of plasma with a resultant change in the conductivity; the conductivity perturbation  $\sigma$  can be written

$$-i\omega\sigma - i\frac{ck_y}{B_z}\frac{d\sigma_0}{dx}\varphi = -\chi k_z^2\sigma, \tag{11.2}$$

where the coefficient  $\chi$  takes account of the "equalization" of the electrical conductivity along the lines of force: in a fully ionized plasma,  $\chi$  is the thermal conductivity and in a weakly ionized (but highly "magnetized") plasma,  $\chi$  is  $D_a$ , the ambipolar diffusion coefficient. We can now find  $\omega$  from Eqs. (11.1) and (11.2):

$$\omega = -i\chi k_z^2 + i\frac{k_y E_0 c}{k_z B_z \sigma_0} \frac{d\sigma_0}{dx}. \tag{11.3}$$

If  $k_y$  is large, the second term in Eq. (11.3) can be larger than the first and the corresponding perturbation will grow.

Let us consider in greater detail the origin of this instability, which we will call the current convective instability. Let us suppose that  $d\sigma/dx < 0$ , and that the plasma is displaced from equilibrium position as shown in Fig. 16. Since the conductivity of layer ABCD is increased as a consequence of this displacement, charges will accumulate at its boundary surfaces — positive charge at the upper surface and negative charge at the lower surface. These charges give rise to an electric field with a nonvanishing  $E_y$  component. If the sign of  $k_y/k_z$  is appropriate, the drift due to this field will be in the same direction as the original displacement and will reinforce the original perturbation.

It is evident from Eq. (11.3) that the highest growth rates are to be associated with small  $k_z$ , i.e., this instability is manifest in the displacement of a plasma tube which is highly elongated along the lines of force of the magnetic field. In order to determine the wave number  $k_z$  for which the

From Eqs. (12.3) and (12.4) we find the dispersion equation for determining the frequency of the small oscillations  $\omega$ :

$$(\omega^2 + i\omega\nu_s - c_A^2 k_z^2)(\omega + i\chi_{||} k_z^2 + i\chi_{\perp} k_{\perp}^2 + i\nu_r + i\nu_q) + 2\omega\nu_s \nu_q \frac{k_{\perp}^2}{k^2} = 0, \tag{12.5}$$

where

$$\nu_s = \frac{c^2 k_z^2}{4\pi\sigma_0}; \quad \nu_r = \frac{2}{3n_0} \frac{dQ_r}{dT_0}; \quad \nu_q = \frac{2j_0^2}{3n_0 T_0 \sigma_0} \frac{d \ln \sigma_0}{d \ln T_0}.$$

If  $\nu_q = 0$ , i.e., if the conductivity is independent of temperature, Eq. (12.5) shows that the oscillations split into Alfvén waves and temperature perturbations which are damped as a consequence of the thermal conductivity and radiation ( $\nu_r > 0$ ). A similar splitting takes place if  $\nu_q \neq 0$ , provided the magnetic field is very strong, i.e.,  $c_A k_z$  must be larger than all of the other characteristic frequencies. In this case, the frequency for the thermal perturbations  $\omega$  is

$$\omega = -i\chi_{||} k_z^2 - i\chi_{\perp} k_{\perp}^2 - i\nu_r - i\nu_q. \tag{12.6}$$

These perturbations can grow only if  $\nu_q < 0$ , i.e., if the conductivity diminishes with temperature.

Now let us consider shortwave perturbations, for which  $\nu_s$  is appreciably higher than the other characteristic frequencies. Going to the limit  $\nu_s \rightarrow \infty$ , we find

$$\omega = -i\chi_{||} k_z^2 - i\chi_{\perp} k_{\perp}^2 - i\nu_r + i\nu_q \frac{k_{\perp}^2 - k_z^2}{k^2}. \tag{12.7}$$

It is evident that the instability can now arise for either positive or negative  $\nu_q$ . In the first case, the instability appears in the formation of a filament of higher conductivity which extends along the lines of force of the magnetic field; in the second case, the instability appears in the form of alternating layers of high and low conductivity similar to the striations in a glow discharge. However, since the electron thermal conductivity is very high along the field lines, in a fully ionized plasma an instability will arise only for perturbations which are highly elongated along the magnetic field ( $k_z \rightarrow 0$ ). In this case, the plasma is unstable only if  $\nu_q > 0$ , which corresponds precisely to the actual conditions in a fully ionized plasma in which the conductivity is proportional to the electron temperature to the  $3/2$  power.

carrying a current increases the conductivity; in turn, the higher conductivity means a higher current flow, with further overheating, and so on.

As a simple example, let us consider the following idealized problem. Assume that a current  $j_0$  flows along a uniform magnetic field  $B_0$  in the  $z$  direction; the current is so weak that the magnetic field it produces can be neglected. We also assume that the plasma pressure is much smaller than the magnetic pressure. In this case, the equation of motion for small oscillations can be written in the form

$$-i\omega v = \frac{1}{Mn_0 c} [jB_0], \tag{12.1}$$

where  $M$  is the ion mass,  $v$  is the ion velocity,  $n_0$  is the density, and  $j$  is the current density. If the ions are cold, Ohm's law can be written in the form

$$E = -\frac{1}{c} [vB_0] + \frac{j}{\sigma_0} - \frac{j_0}{\sigma_0} \frac{d \ln \sigma_0}{d \ln T_0} \frac{T}{T_0}, \tag{12.2}$$

where  $j$  is the current perturbation;  $T_0$  is the equilibrium electron temperature, and  $T$  is the temperature perturbation.

Substituting the expression for the field (12.2) in the equation  $\partial j/\partial t = -c^2/4\pi \text{rot rot } E$ , which derives from Maxwell's equations, and eliminating  $v$  by means of Eq. (12.1), we have

$$\left( \omega^2 + i\omega \frac{c^2 k_{\perp}^2}{4\pi\sigma_0} - c_A^2 k_z^2 \right) j_z = i\omega \frac{c^2 k_{\perp}^2}{4\pi\sigma_0} j_0 \frac{d \ln \sigma_0}{d \ln T_0} \frac{T}{T_0}, \tag{12.3}$$

where  $c_A = B_0/(4\pi n_0 M)^{1/2}$  is the Alfvén velocity and  $k$  is the wave number for small oscillations of the form  $\exp(-i\omega t + ikx)$ .

The temperature  $T$  can be found from the heat balance equation. We assume that plasma is uniform in the equilibrium state and that the Joule heat  $j_0^2/\sigma_0$  is completely carried away by radiation  $Q_r(T_0)$ . Then, neglecting the displacement of the plasma along  $z$ , we can write the linearized heat-balance equation in the form

$$\begin{aligned} \left( -i\omega + \chi_{||} k_z^2 + \chi_{\perp} k_{\perp}^2 + \frac{2}{3\pi_0} \frac{dQ_r}{dT_0} + \frac{2j_0^2}{3n_0 T_0 \sigma_0} \frac{d \ln \sigma_0}{d \ln T_0} \right) \frac{T}{T_0} = \\ = \frac{4j_0}{3n_0 T_0 \sigma_0} j_z, \end{aligned} \tag{12.4}$$

where  $\chi$  is the thermal conductivity (anisotropic).

It should be noted that the growth time for this instability is relatively large, being of the order of the penetration time. Hence, it is difficult to say whether it appears under actual conditions. On the one hand, the long wavelength perturbations ( $k^2 < 4\pi\sigma_0 k_A k_z c^{-2}$ ) are stabilized in a strong magnetic field and a current pinch has a tendency to break up into many filaments which are highly elongated along the lines of force of the magnetic field. The growth time for this instability is of the same order as the time required for the production of the discharge, so the possibility is not excluded that this instability will appear as a contraction of the discharge as a whole as occurs, for example, in the pinching of an ordinary arc.

## LITERATURE CITED

1. M. A. Leontovich, Plasma Physics and the Problem of Controlled Thermonuclear Reactions (translated from the Russian), Pergamon Press, New York, 1959, Vol. I.
2. M. A. Leontovich and V. D. Shafranov, *ibid.*, Vol. I.
3. B. A. Trubnikov, *ibid.*, Vol. I.
4. V. D. Shafranov, *ibid.*, Vol. II.
5. T. F. Volkov, *ibid.*, Vol. II.
6. V. D. Shafranov, Atomnaya energiya (Atomic Energy), 5, 38 (1956).
7. M. D. Kruskal and M. Schwarzschild, Proc. Roy. Soc. (London) A233, 348 (1954).
8. S. Chandrasekhar and E. Fermi, Astrophys. J. 118, 116 (1953).
9. V. D. Shafranov, Plasma Physics and the Problems of Controlled Thermonuclear Reactions (translated from the Russian), Pergamon Press, New York, 1959, Vol. IV.
10. R. Taylor, cited in Artsimovich, Controlled Thermonuclear Reactions (translated from the Russian), Gordon and Breach, New York, 1965.
11. P. Roberts, Astrophys. J. 124, 430 (1956).
12. S. Lundquist, Phys. Rev. 83, 307 (1951).
13. S. I. Braginskii, Plasma Physics and the Problem of Controlled Thermonuclear Reactions (translated from the Russian), Pergamon Press, New York, 1959, Vol. III.
14. Heine, Lüst, and Schlüter, cited in Artsimovich, Controlled Thermonuclear Reactions, Gordon and Breach, New York, 1965.
15. Bernstein, Frieman, Kruskal, and Kulsrud, *ibid.*
16. M. N. Rosenbluth and C. Longmire, Ann. Phys. 1, 120 (1957).
17. B. B. Kadomtsev, Plasma Physics and the Problem of Controlled Thermonuclear Reactions (translated from the Russian), Pergamon Press, New York, 1959, Vol. IV.

18. M. N. Rosenbluth, Proceedings of the 2nd International Conference on the Peaceful Uses of Atomic Energy, Geneva (1958).
19. Suydam, *ibid.*
20. Berkowitz, Grad, and Rubin, *ibid.*
21. Johnson, Oberman, Kruskal, and Frieman, *ibid.*
22. Kruskal, Johnson, Gottlieb, and Goldman, Phys. Fluids 1, 421 (1958).
23. B. B. Kadomtsev, ZhÉTF 37, 1096 (1959), Soviet Phys. JETP 10, 780 (1960).
24. B. B. Kadomtsev, Proceedings of the 2nd International Conference on the Peaceful Uses of Atomic Energy, Geneva (1958).
25. C. Mercier, Nucl. Fusion 1, 47 (1960).
26. W. A. Newcomb, Ann. Phys. 10, 232 (1960).
27. B. B. Kadomtsev and V. E. Rokotyan, DAN 133, 68 (1960), Soviet Phys. Doklady 5, 747 (1961).
28. E. P. Velikhov, ZhÉTF 31, 180 (1961), Soviet Phys. Technical Physics 6, 130 (1961).
29. S. N. Breus, ZhÉTF 30, 1030 (1960), Soviet Phys. Technical Physics 5, 960 (1961).
30. B. B. Kadomtsev and A. V. Nedospasov, J. Nucl. Energy: Part C 1, 230 (1960).
31. W. A. Newcomb, Phys. Fluids 4, 391 (1961).
32. Yu. V. Vandakurov, ZhÉTF 30, 330 (1960); 30, 781 (1960). Soviet Phys. Technical Physics 5, 305 (1960); 5, 734 (1961).
33. Vedenov, Velikhov, and Sagdeev, UFN 73, 701 (1961), Soviet Phys. Uspekhi, 4, 332 (1961).
34. Furth, Rosenbluth, and Killeen, Phys. Fluids 6, 459 (1963).
35. P. H. Rebut, J. Nucl. Energy: Part C 4, 159 (1961).
36. B. B. Kadomtsev, Nucl. Fusion 1, 286 (1961).